



## **Cables and cable systems for photovoltaic installations**

# Welcome to HELUKABEL®



Logistics Centre, Hemmingen / Germany



Production facility with a modern photovoltaic system, Windsbach / Germany

HELUKABEL® is a leading international manufacturer and supplier of wire & cable, custom cable, cable accessories, data, network, bus and media technology, as well as robotic assemblies. Our headquarters in Germany and warehouses in over 40 countries serve costumers all over the world.

With more then 30 years of experience in the field of wire and cable we have the adequate solutions for photovoltaic applications. In the early 90s we developed the first PV-cables that are marketed today under our leading SOLARFLEX® trademark with global approvals of TÜV and VDE. Together with our state of the art PV-connectors we offer our customers in the photovoltaic industry assembled PV-cables and strings for a quick plug-and-play on site installation. All our products are RoHS-compliant and we are certified according to DIN ISO 9001 and 14001.

HELUKABEL® is your one-stop solution provider for wiring photovoltaic systems.



# Contents

---

Reference cabling .....	4 - 5
Photovoltaic cables .....	6 - 9
SOLARFLEX®-X PV1-F .....	7
SOLARFLEX®-X PV1-F TWIN .....	8
Pre-assembled solutions .....	10 - 17
Chains.....	11 - 13
PV wiring fuse/diode, pre-assembled potential equalization cable .....	14
Adapters.....	16
Photovoltaic cables.....	16 - 17
Components .....	18 - 26
Panel boxes.....	19
Male and female connectors.....	20 - 24
Branches.....	25 - 26
Cable Accessories .....	27 - 32
Cable glands.....	28
Miscellaneous.....	29 - 32
Tools .....	33 - 38
Cables & wires .....	39 - 64
PVC control cables.....	40 - 43
Allweather and rubber cables.....	44 - 45
Power cables.....	46 - 56
Installation cables.....	57
Medium voltage cables.....	58 - 68
Notes.....	69
Achieving success through quality and innovation.....	70
HELUKABEL® – global network .....	71



We have combined our product groups for renewable energies under the term HELUKABEL® GREEN LINE. From cables and wires for photovoltaic and wind turbine systems to biofuels and composting systems, HELUKABEL® has a comprehensive product range - developed, produced and tested in our own plant in Windsbach, Germany.

In the area of renewable energies our cables have been developed with particular characteristics that can perform within the harsh conditions of solar and wind environments. These are especially the changing weather conditions and the partially extreme mechanical loads.

Due to the worldwide leading role of German companies in the area of renewable energies, it must also be taken into consideration that the climatic conditions in Southern Europe, Africa or Arctic regions are much more demanding than those in temperate central Europe. These environmental conditions and several system-specific parameters impose greater stress and therefore require technical advanced cable.

With more than 30 years of experience in cable development and production, using the most modern materials and based on the latest research results, HELUKABEL® has developed cables which are optimised for these application areas.



# HELUKABEL® reference cabling – open land



A solar plant on open land

Photo: HELUKABEL®

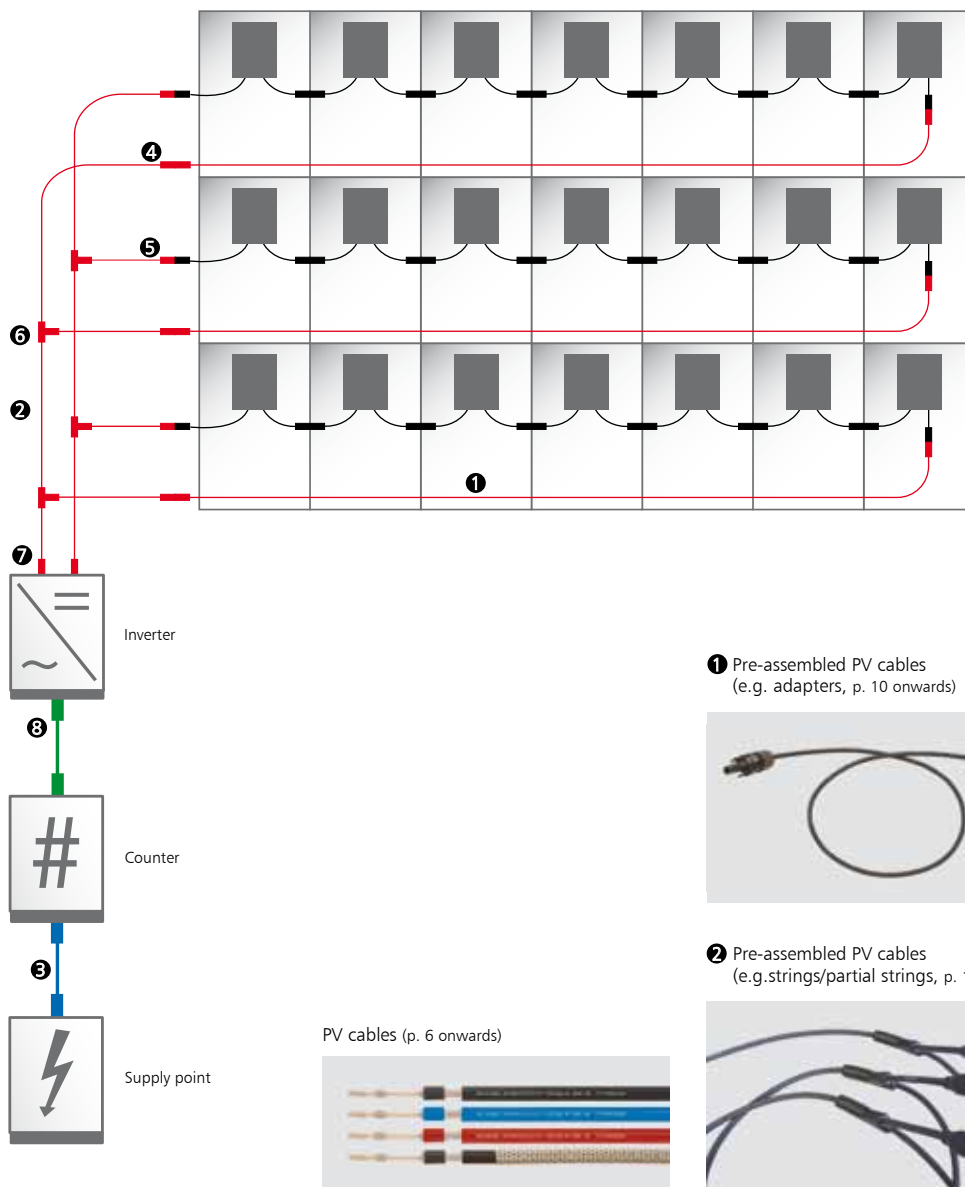

③ Cables & Wires (p. 39 onwards)



④ Connector (e.g. MC 3 p. 22, H4 p. 21)



⑤ Mating connector for male inverter connector (e.g. MC, p. 20 onwards)



⑥ Split (e.g. T-/Y-split, p. 11 onwards)



① Pre-assembled PV cables (e.g. adapters, p. 10 onwards)

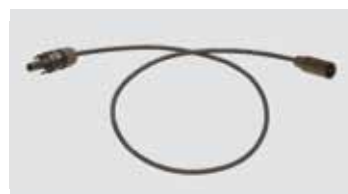

② Pre-assembled PV cables (e.g. strings/partial strings, p. 10)



PV cables (p. 6 onwards)



⑦ Assembly connector for male inverter connector available on request



⑧ Cable glands (p. 28)



# HELUKABEL® reference cabling – building



Solar panels on a farm

Photo: HELUKABEL®

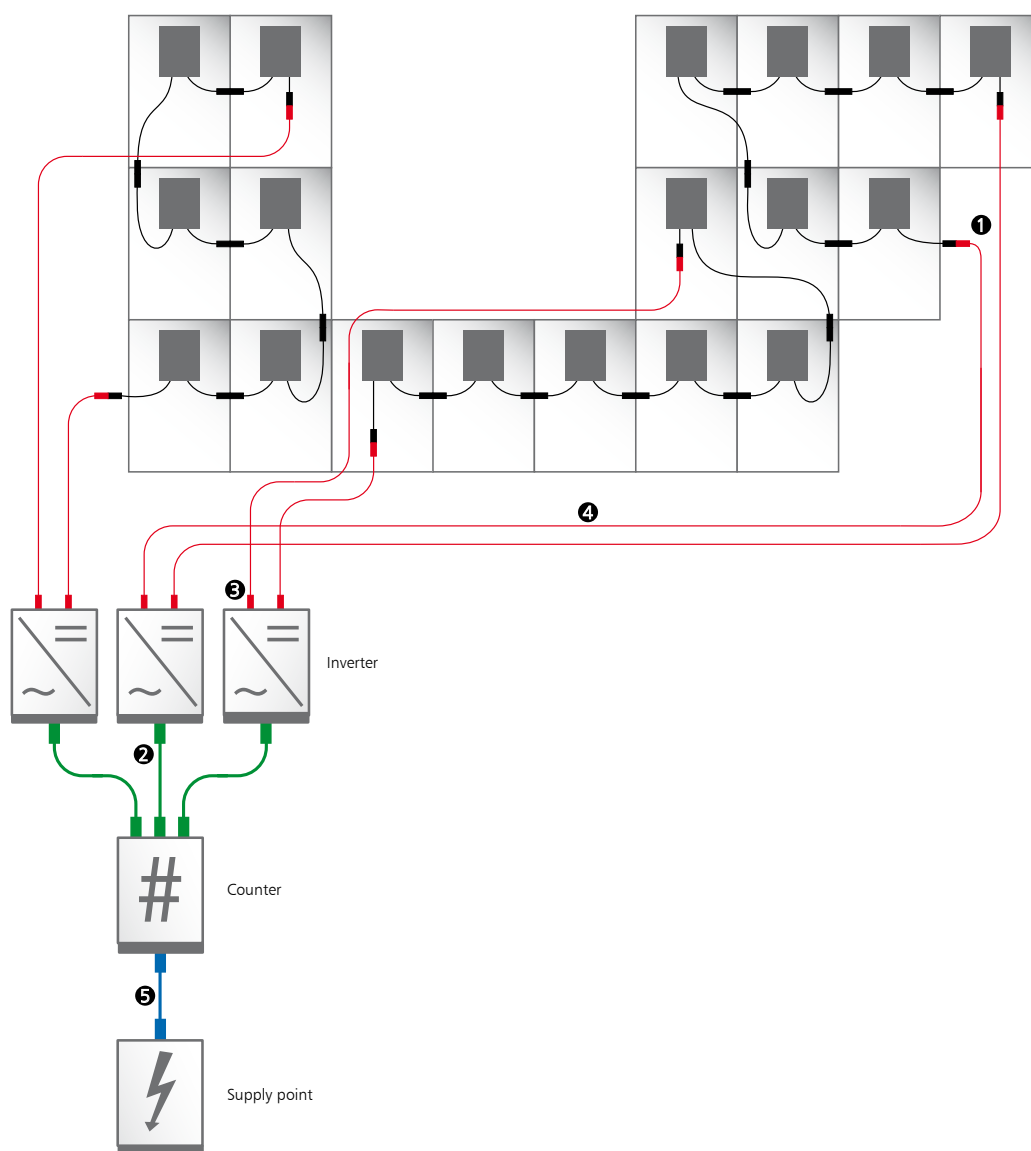

❶ Mating connector for male inverter connector (e.g. MC, p. 20 onwards)



❷ Cable glands (p. 28)



❸ Assembly connector for male inverter connector available on request

❹ Pre-assembled PV cables (e.g. adapters, p. 10 onwards)



❺ Cables & wires (p. 39 onwards)



PV cables (p. 6 onwards)



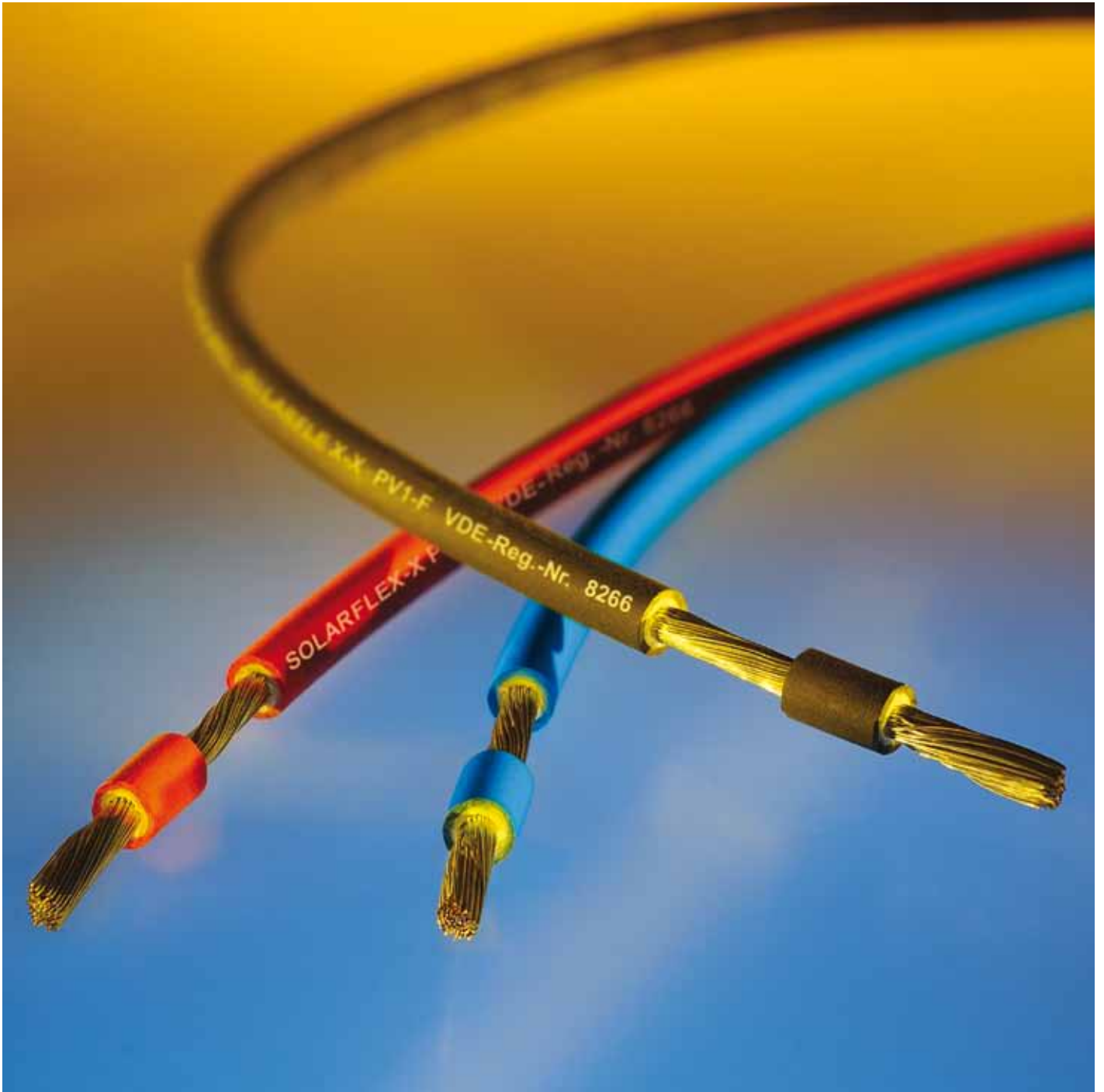
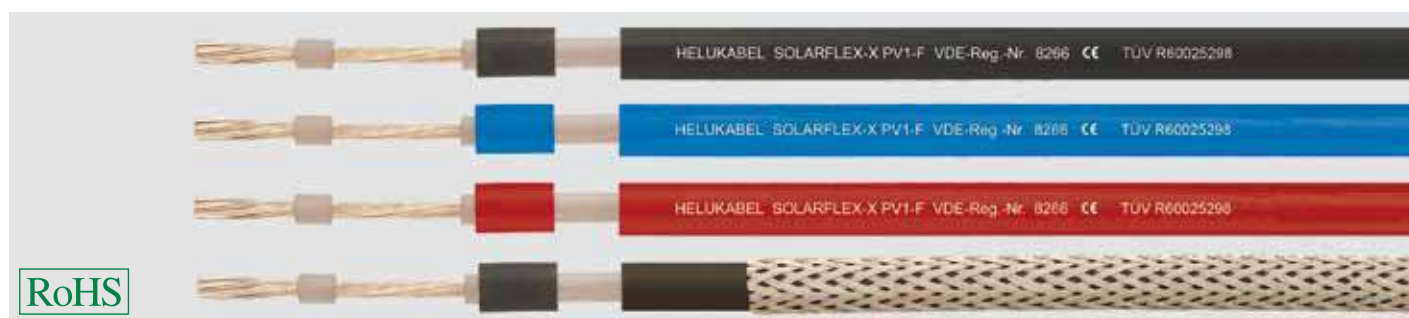

Photo: HELUKABEL®

# Photovoltaic cables



RoHS

## Technical Data

- **Temperature range**  
-40 °C to +90 °C  
Max. temp. at conductor +120 °C
- **Nominal voltage**  
According to VDE U<sub>0</sub>/U 600/1000 V AC  
1800 V DC conductor/conductor
- **AC test voltage**  
10000 V
- **Minimum bending radius**  
fixed installation approx. 4 x outer diameters  
flexing 10 x cable diameter

## Cable structure

- Bare copper, tinned, finely stranded according to DIN VDE 0295 class 5 and IEC 60228 cl. 5
- Double-insulated
- Insulation cross-linked Polyolefin
- Outer sheath cross-linked Polyolefin
- Sheath colour black, red or blue

## Approvals

- According to PV1-F requirement profile for PV cables DKE/VDE AK 411.2.3
- VDE (Reg. 8266)
- TÜV (2 PfG 1169/08.2007, R60025298)
- RoHS and CE compliant

## Properties

- Ozone resistant acc. to EN 50396
- Weather and UV resistant acc. to HD 605/A1
- Halogen-free acc. to EN 50267-2-1, EN 60684-2
- Resistant to acid and bases acc. to EN 60811-2-1
- Flame-resistant acc. to VDE 0482-332-1-2, DIN EN 60332-1-2, IEC 60332-1
- Very robust and abrasion-resistant sheath acc. to DIN EN 53516
- Resistant to short-circuits up to 200°C thanks to their double insulation; short-circuits temperature 200°C/ 5 sec.
- Anticipated service life - 25 years
- Hydrolysis and ammoniac resistant

## Notes

- Version with rodent protection available
- UL version on request
- All types with metre marking

## Application

The SOLARFLEX®-X PV1-F is used for cabling solar modules.

Part No.	No. cores x cross-sec. mm <sup>2</sup>	Outer Ø app. mm	Cop. weight kg / km	Weight app. kg / km	Current-carrying capacity [A] at 60°C	Conductor resistance Ω / km at 20°C	Core / jacket colour
704225	1 x 2,5	4,5	24,0	42	41	8,210	natural/black
705891	1 x 2,5	4,5	24,0	42	41	8,210	natural/red
705892	1 x 2,5	4,5	24,0	42	41	8,210	natural/blue
704226	1 x 4	5,2	38,4	60	55	5,090	natural/black
705775	1 x 4	5,2	38,4	60	55	5,090	natural/red
705776	1 x 4	5,2	38,5	60	55	5,090	natural/blue
704227	1 x 6	5,9	57,6	82	70	3,390	natural/black
705777	1 x 6	5,9	57,6	82	70	3,390	natural/red
705778	1 x 6	5,9	57,6	82	70	3,390	natural/blue
704228	1 x 10	6,9	96,0	123	98	1,950	natural/black
705893	1 x 10	6,9	96,0	123	98	1,950	natural/red
705894	1 x 10	6,9	96,0	123	98	1,950	natural/blue
704229	1 x 16	8,3	153,6	190	132	1,240	natural/black
706839	1 x 16	8,3	153,6	190	132	1,240	natural/red
706840	1 x 16	8,3	153,6	190	132	1,240	natural/blue
704230	1 x 25	10,0	240,0	285	176	0,795	natural/black
704231	1 x 35	11,0	336,0	376	218	0,565	natural/black
704232	1 x 50	13,0	480,0	530	276	0,393	natural/black
704233	1 x 70	15,3	672,0	745	347	0,277	natural/black
704234	1 x 95	17,0	912,0	960	416	0,210	natural/black
705738	1 x 120	19,1	1152	1220	488	0,164	natural/black
705739	1 x 150	22,7	1440	1550	566	0,132	natural/black
706288	1 x 185	25,5	1776	1930	644	0,108	natural/black
706289	1 x 240	28,3	2304	2550	775	0,0817	natural/black

Dimensions and specifications may be changed without prior notice.

# SOLARFLEX®-X PV1-F TWIN



## Technical Data

- **Temperature range**  
-40 °C to +90 °C  
Max. temp. at conductor +120 °C
- **Nominal voltage**  
According to VDE U<sub>0</sub>/U 600/1000 V AC  
1800 V DC conductor/conductor
- **AC test voltage**  
6500 V, 50 Hz
- **Minimum bending radius**  
Single 1.5 cable diameters  
Multiple 10 cable diameters

## Cable structure

- Bare copper, Class 5, tinned, finely stranded according to DIN VDE 0295 class 5 and IEC 60228 cl. 5
- Double-insulated
- Insulation cross-linked special Polyolefin
- Outer sheath cross-linked special Polyolefin
- Sheath colour: black

## Properties

- Approval: TÜV 2Pfg1169/08.2007
- UV, ozone-resistant, weather-resistant,
- Halogen-free
- Abrasion and cut resistant
- Relatively flexible
- Easy to strip
- Flame-resistant according to VDE 0482 Part 332-1-2, IEC 60332-1-2
- Resistant to short circuits up to 200 °C thanks to double insulation, short circuit temperature 200 °C/5 sec.
- Anticipated service life 25 years

## Application

The SOLARFLEX®-X PV1-F TWIN is used for cabling solar modules.

Part No.	No. cores x cross-sec. mm <sup>2</sup>	Outer Ø app. mm	Cop. weight kg / km	Weight app. kg / km	Core / jacket colour
705769	2 x 6	6.8 x 13.6	120.0	186.8	red, black/black

Cross-sections up to 2 x 16 mm<sup>2</sup> are available on request

Dimensions and specifications may be changed without prior notice.



Photo: HELUKABEL®

SOLARFLEX®-X PV1-F



# Cable - connector combinations

		Type	MC4	MC4	MC4	MC4	MC3	MC3
<b>Cross section</b>			2.5 mm <sup>2</sup>	4 - 6 mm <sup>2</sup>	4 - 6 mm <sup>2</sup>	10 mm <sup>2</sup>	2.5 - 4 mm <sup>2</sup>	2.5 - 4 mm <sup>2</sup>
<b>Outer-ø</b>			3 - 6 mm	3 - 6 mm	5.5 - 9 mm	5.5 - 9 mm	3.2 - 4.8 mm	4.9 - 7.1 mm
<b>Male connector</b>			905206	905210	904963	905863	905202	904955
<b>Female connector</b>			905207	905211	904964	905864	905203	904956
<b>Cross section</b>	<b>Outer-ø</b>	<b>Cable</b>						
2,5 mm <sup>2</sup>	4,3 - 4,7 mm	704225	●	-	-	-	●	-
4 mm <sup>2</sup>	5 - 5,4 mm	704226	-	●	-	-	-	●
6 mm <sup>2</sup>	5,7 - 6,1 mm	704227	-	-	●	-	-	-
10 mm <sup>2</sup>	6,7 - 7,1 mm	704228	-	-	-	●	-	-

		Type	MC3	HC3	HC3	HC3
<b>Cross section</b>			6 mm <sup>2</sup>	2.5 - 4 mm <sup>2</sup>	2.5 - 4 mm <sup>2</sup>	6 mm <sup>2</sup>
<b>Outer-ø</b>			4.9 - 7.1 mm	3.2 - 6 mm	4.9 - 8.2 mm	5.2 - 7 mm
<b>Male connector</b>			905204	905244	904959	905246
<b>Female connector</b>			905205	905245	904960	905247
<b>Cross section</b>	<b>Outer-ø</b>	<b>Cable</b>				
2,5 mm <sup>2</sup>	4,3 - 4,7 mm	704225	-	●	-	-
4 mm <sup>2</sup>	5 - 5,4 mm	704226	-	-	●	-
6 mm <sup>2</sup>	5,7 - 6,1 mm	704227	●	-	-	●
10 mm <sup>2</sup>	6,7 - 7,1 mm	704228	-	-	-	-

		Type	H4	H4	H4	Sunclix
<b>Cross section</b>			4 mm <sup>2</sup>	6 mm <sup>2</sup>	10 mm <sup>2</sup>	2.5 - 6 mm <sup>2</sup>
<b>Outer-ø</b>			4.5 - 7.8 mm	4.5 - 7.8 mm	4.5 - 7.8 mm	5.2 - 7.0 mm
<b>Male connector</b>			905593	905595	905937	906165
<b>Female connector</b>			905594	905596	905938	906166
<b>Cross section</b>	<b>Outer-ø</b>	<b>Cable</b>				
2,5 mm <sup>2</sup>	4,3 - 4,7 mm	704225	●	-	-	●
4 mm <sup>2</sup>	5 - 5,4 mm	704226	●	-	-	●
6 mm <sup>2</sup>	5,7 - 6,1 mm	704227	-	●	-	●
10 mm <sup>2</sup>	6,7 - 7,1 mm	704228	-	-	●	-



Photo: HELUKABEL®

# Pre-assembled solutions

We offer individual cable solutions for professional and safe cabling. Pre-assembled solutions ensure consistently high levels of quality and speed up assembly. Costs are reduced thanks to standardization.

## Chains

SOLARFLEX® cables are assembled, connected and sealed (Macromelt melting process). This significantly reduces the number of parts involved and, in turn, the failure rate. (Page 11 onwards)

## PV wiring fuse/diode, pre-assembled potential equalization cable (Page 14)

## Adapters

For connecting MC male and female connectors to male and female coupling connectors of different connecting systems. (Page 16)

## PV cables

For establishing a connection with panel boxes or inverters, for connecting modules; available in any length and with pre-assembled male and female connectors. (Page 16 )

# HELUSOL 101 Y-split



## Technical data:

- Cross section 4 and 6 mm<sup>2</sup>
- Rated voltage 1100 V
- Contact resistance <0.1 mΩ
- Test voltage 12 kV
- Application temperature -40°C up to +85°C
- Application class A acc. to IEC 61730-1
- IP class IP 68
- Protection class II
- Extrusion Hot-melt, low-pressure method
- Material Macromelt OM 648 (black)
- Test specifications acc. to DIN EN 50521

# HELUSOL 102 T-split



## Technical data:

- Cross section 2.5 to 16 mm<sup>2</sup>
- Rated voltage 1000 V
- Contact resistance <2 mΩ
- Application temperature -40°C up to +140°C
- IP class Corresponds to IP67
- Protection class II (reinforced insulation)
- Extrusion Hot-melt, low-pressure method
- Material Macromelt OM 648 (black)
- UV and weather resistant
- Test specifications EN 60664-1

# HELUSOL 103 E-split



## Technical data:

- Cross section 2.5 to 16 mm<sup>2</sup>
- Rated voltage 1000 V
- Contact resistance <2 mΩ
- Application temperature -40°C up to +140°C
- IP class Corresponds to IP67
- Protection class II (reinforced insulation)
- Extrusion Hot-melt, low-pressure method
- Material Macromelt OM 648 (black)
- UV and weather resistant
- Test specifications EN 60664-1

# HELUSOL 106 TWIN-split



## Technical data:

- Cross section 2.5 to 16 mm<sup>2</sup>
- Rated voltage 1000 V
- Contact resistance <2 mΩ
- Application temperature -40°C up to +140°C
- IP class Corresponds to IP67
- Protection class II (reinforced insulation)
- Extrusion Hot-melt, low-pressure method
- Material Macromelt OM 648 (black)
- UV and weather resistant
- Test specifications EN 60664-1

# HELUSOL 103 Duo-split



## Technical data:

- Cross section 2.5 to 16 mm<sup>2</sup>
- Rated voltage 1000 V
- Contact resistance <2 mΩ
- Application temperature -40°C up to +140°C
- IP class Corresponds to IP67
- Protection class II (reinforced insulation)
- Extrusion Hot-melt, low-pressure method
- Material Macromelt OM 648 (black)
- UV and weather resistant
- Test specifications EN 60664-1

# HELUSOL 106 U-split



## Technical data:

- Cross section 2.5 to 16 mm<sup>2</sup>
- Rated voltage 1000 V
- Contact resistance <2 mΩ
- Application temperature -40°C up to +140°C
- IP class Corresponds to IP67
- Protection class II (reinforced insulation)
- Extrusion Hot-melt, low-pressure method
- Material Macromelt OM 648 (black)
- UV and weather resistant
- Test specifications EN 60664-1

# PV wiring fuse/diode

---



## PV wiring fuse

### Technical Data

- Operating current: up to 20 A
- Voltage: 900 V (controlled by fuse)
- Temperature range: -40°C up to +120°C
- Protection classification: equates to IP 67
- Protection type: II
- UV and weather resistant

### Note

- Customer-specific design

## PV wiring diode

### Technical Data

- Operating current: 5 A
- Max. average forward current (R-Load, TA = 50 °C IFAV): 5 A
- Reverse voltage: 50 to 1000 V
- Temperature range: -40°C up to +120°C
- Protection classification: equates to IP 67
- Protection type: II
- UV and weather resistant

### Note

- Customer-specific design

# Pre-assembled potential equalization cable

---



We offer customized pre-assembled solutions for our robust and weather resistant SOLARFLEX®-X PV1-F according to your needs.

Please tell us your performance requirements.

Copy and fax straight to  
+49 7150 959225

# FAX enquiry form for pre-assembled chains

## HELUSOL 101 Y-split

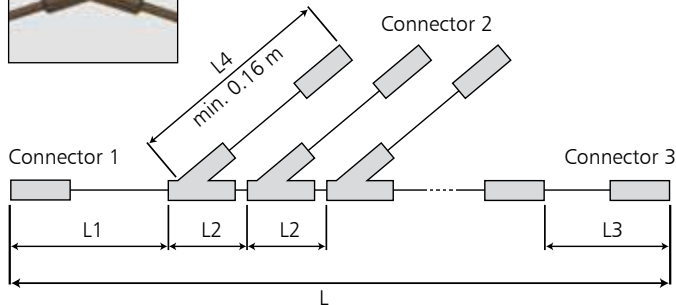

## HELUSOL 102 T-split

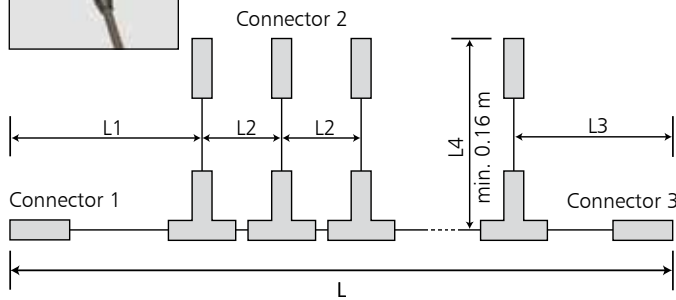

## Your requirements

Split type (please mark with a cross)  Y-split  T-split

Project name \_\_\_\_\_

Quantity \_\_\_\_\_ pcs.

Cross section  
Main line \_\_\_\_\_ mm<sup>2</sup>  
Secondary line \_\_\_\_\_ mm<sup>2</sup>

Total length L \_\_\_\_\_ m

Distance between branches L2 \_\_\_\_\_ m

No. of branches \_\_\_\_\_ pcs.

Distance to 1st branch L1 \_\_\_\_\_ m

Distance from final branch L3 \_\_\_\_\_ m

Length of secondary line L4 \_\_\_\_\_ m

	Connector 1	Connector 2	Connector 3
MC4 2.5-10 mm <sup>2</sup>			
MC3 2.5-6 mm <sup>2</sup>			
HC3 2.5-6 mm <sup>2</sup>			
H4 2.5-10 mm <sup>2</sup>			
Sunclix 2.5-6 mm <sup>2</sup>			

More connectors on request

Please enter: Mc= male connector, Fc= female connector

## Your contact details

Company \_\_\_\_\_  
first name, last name \_\_\_\_\_  
Address \_\_\_\_\_  
Post code, town/city \_\_\_\_\_  
Phone/Fax \_\_\_\_\_  
E-mail \_\_\_\_\_

Please send us the following catalogues

- Cables & Wires
- Cable Accessories
- Data, Network & Bus Technology
- Media Technology
- General documentation

We would like

- A customer visit
- General documentation

# Individual PV adapter



RoHS

More combinations on request

E.g. MC4 female connector / MC3 male connector

# PV cable female connector/male connector



RoHS

Designation	Side A	Side B	Length
PV cable MC3 Fc/Mc	MC3 female connector	MC3 male connector	On request
PV cable MC4 Fc/Mc	MC4 female connector	MC4 male connector	On request
PV cable HC3 Fc/Mc	HC3 female connector	HC3 male connector	On request
PV cable Tyco Solarlock Fc/Mc	Tyco Solarlock female connector	Tyco Solarlock male connector	On request
PV cable H+S Radox Fc/Mc	H+S Radox female connector	H+S Radox male connector	On request
PV cable Hirschmann SunCon Fc/Mc	Hirschmann SunCon female connector	Hirschmann SunCon male connector	On request
PV cable Yukita Fc/Mc	Yukita female connector	Yukita male connector	On request
PV cable Lumberg-B/S	Lumberg-female connector	Lumberg-male connector	On request
PV cable Phoenix Contact	Phoenix Contact-female connector	Phoenix Contact-male connector	On request
PV cable Amphenol	Amphenol-female connector	Amphenol-male connector	On request
PV cable Eldra	Eldra-female connector	Eldra-male connector	On request
PV cable Wieland	Wieland-female connector	Wieland-male connector	On request

More combinations on request



Copy and  
fax straight to  
+49 7150 959225

# FAX enquiry form for PV cables

## Pre-assembled photovoltaic cables

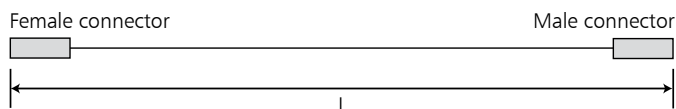

Project name

Quantity  pcs.

Cross section  mm<sup>2</sup>

Total length L  m

	Type of connector
MC4 2.5-10 mm <sup>2</sup>	<input type="checkbox"/>
MC3 2.5-6 mm <sup>2</sup>	<input type="checkbox"/>
HC3 2.5-6 mm <sup>2</sup>	<input type="checkbox"/>
H4 2.5-10 mm <sup>2</sup>	<input type="checkbox"/>
Sunclix 2.5-6 mm <sup>2</sup>	<input type="checkbox"/>

More connectors on request

## Your contact details

Company

first name, last name

Address

Post code, town/city

Phone/Fax

E-mail

Please send us the following catalogues

- Cables & Wires
- Cable Accessories
- Data, Network & Bus Technology
- Media Technology
- General documentation

We would like

- A customer visit
- General documentation

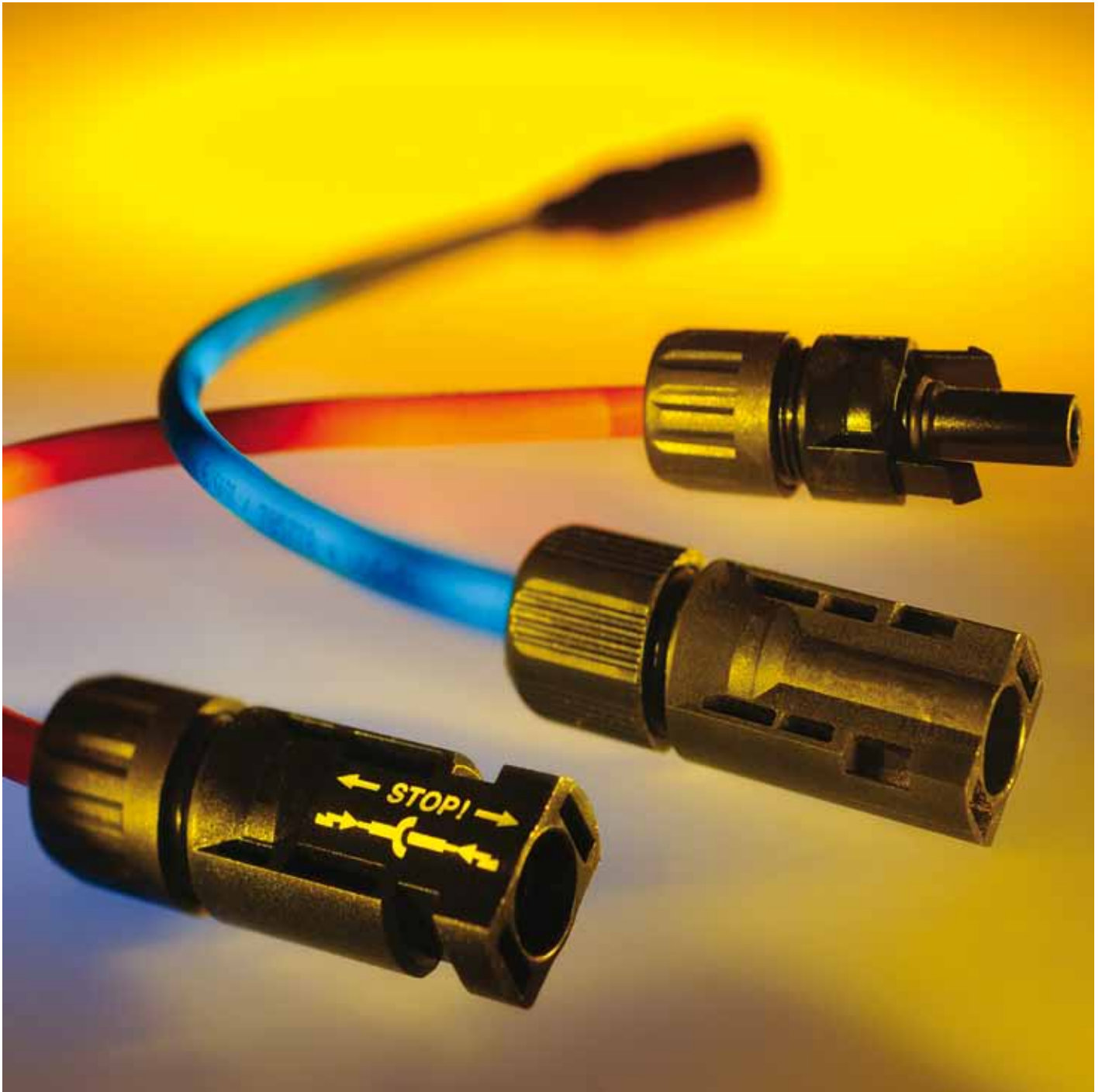

Photo: HELUKABEL®

# Components

Components for on-site electrical connection and assembly work.

## **Panel boxes**

For electrical connection and reliable operation of solar modules. (Page 19)

## **PV couplings and branches**

For connecting to solar cables and linking the various assemblies. (Page 20 onwards)

# Photovoltaic panel box PV-JB

---



Suitable for connecting SOLARFLEX®-X PV1-F cables to the core cross-sections 2.5 mm<sup>2</sup>, 4 mm<sup>2</sup> and 6 mm<sup>2</sup>. With two bypass diodes. Preventing condensation using a bronze air filter. A set of adhesive elements are included for tight and lasting mounting on any solar module.

We offer pre-assembled solutions in your desired cable lengths and cross-sections.  
If you need special capacity types please do not hesitate to contact us!

## Material

- Casing: PC (polycarbonate),
- UV-resistant

## Technical Data

- Temperature range: -40° C up to +125° C
- Operating power: 9-20 A
- Working voltage: 600 V
- Breakdown Voltage: 1000 V
- Contact resistance: <2 mΩ
- Isulation resistance: >500 mΩ
- Protection classification: IP 67

# Photovoltaic panel boxes according to your requirements

---



Do you need a photovoltaic panel box customised to your special requirements?

Just contact us. Various sizes and design variants are possible.

We are happy to provide a customised solution for you. Use the contact details on the last page of the brochure.

# PV MC4 male coupling connector



## Technical Data

- Protection classification: IP 67
- Temperature range: -40°C up to +90°C
- Protection type: II
- Rated voltage: 1000 V (IEC)
- Rated current: 22A (2.5 mm<sup>2</sup>), 30A (4 mm<sup>2</sup> u. 6 mm<sup>2</sup>)
- Contact resistance: <0.5 mΩ
- Contact system: MC contact fins
- Contact material: Copper, tinned, cross-linked

Part No.	Designation	Core cross section mm <sup>2</sup>	Cable Ø mm	Unit Pcs.
905206	PV MC4 male connector 2.5/3-6	2.5	3 - 6	50
905208	PV MC4 male connector 2.5/5.5-9	2.5	5.5 - 9	50
905210	PV MC4 male connector 4-6/3-6	4 - 6	3 - 6	50
904963	PV MC4 male connector 4-6/5.5-9	4 - 6	5.5 - 9	50
905863	PV MC4 male connector 10/5.5-9	10	5.5 - 9	50

# PV MC4 female coupling connector



## Technical Data

- Protection classification: IP 67
- Temperature range: -40°C up to +90°C
- Protection type: II
- Rated voltage: 1000 V (IEC)
- Rated current: 22A (2.5 mm<sup>2</sup>), 30A (4 mm<sup>2</sup> u. 6 mm<sup>2</sup>)
- Contact resistance: <0.5 mΩ
- Contact system: MC contact fins
- Contact material: Copper, tinned, cross-linked

Part No.	Designation	Core cross section mm <sup>2</sup>	Cable Ø mm	Unit Pcs.
905207	PV MC4 female connector 2.5/3-6	2.5	3 - 6	50
905209	PV MC4 female connector 2.5/5.5-9	2.5	5.5 - 9	50
905211	PV MC4 female connector 4-6/3-6	4 - 6	3 - 6	50
904964	PV MC4 female connector 4-6/5.5-9	4 - 6	5.5 - 9	50
905864	PV MC4 female connector 10/5.5-9	10	5.5 - 9	50

# PV H4 male coupling connector

**NEW**



## Technical Data

- Protection classification: IP 68
- Temperature range: -40°C up to +90°C (IEC)
- Rated voltage: 1000 A (IEC)
- Rated current: 45 A (4 mm<sup>2</sup>), 52 A (6 mm<sup>2</sup>)
- Contact resistance: 0.25 mΩ
- Contact material: Copper, tinned, cross-linked
- Insulation material: PBT
- Contact type: cross-linked

RoHS

Part No.	Designation	Core cross section mm <sup>2</sup>	Cable Ø mm	Unit Pcs.
905593	PV-100508-M	4	4,5 - 7,8	100
905595	PV-100506-M	6	4,5 - 7,8	100
905937	PV-100510-M	10	4.5 - 7.8	100

# PV H4 female coupling connector

**NEW**



## Technical Data

- Protection classification: IP 68
- Temperature range: -40°C up to +90°C (IEC)
- Rated voltage: 1000 A (IEC)
- Rated current: 45 A (4 mm<sup>2</sup>), 52 A (6 mm<sup>2</sup>)
- Contact resistance: 0.25 mΩ
- Contact material: Copper, tinned, cross-linked
- Insulation material: PBT
- Contact type: cross-linked

RoHS

Part No.	Designation	Core cross section mm <sup>2</sup>	Cable Ø mm	Unit Pcs.
905594	PV-100508-F	4	4,5 - 7,8	100
905596	PV-080506-F	6	4,5 - 7,8	100
905938	PV-100510-F	10	4.5 - 7.8	100

# PV MC3 male coupling connector



RoHS

## Technical Data

- Protection classification: IP 67
- Temperature range: -40°C up to +90°C
- Protection type: II
- Rated voltage: 1000 V (IEC)
- Rated current: 20 A (2.5 mm<sup>2</sup> - 4 mm<sup>2</sup>), 30 A (6mm<sup>2</sup>)
- Contact resistance: 0.5 mΩ
- Contact material: Copper, tinned, cross-linked

Part No.	Designation	Core cross section mm <sup>2</sup>	Cable Ø mm	Unit Pcs.
905202	PV MC3 male connector 2.5-4/3.2-4.8	2.5 - 4	3.2 - 4.8	50
904955	PV MC3 male connector 2.5-4/4.9-7.1	2.5 - 4	4.9 - 7.1	50

Part No.	Designation	Core cross section mm <sup>2</sup>	Cable Ø mm	Unit Pcs.
905204	PV MC3 male connector 6/4.9-7.1	6	4.9 - 7.1	50
904957	PV MC3 male connector 6/6.5-7.6	6	6.5 - 7.6	50

# PV MC3 female coupling connector



RoHS

## Technical Data

- Protection classification: IP 67
- Temperature range: -40°C up to +90°C
- Protection type: II
- Rated voltage: 1000 V (IEC)
- Rated current: 20 A (2.5 mm<sup>2</sup> - 4 mm<sup>2</sup>), 30 A (6mm<sup>2</sup>)
- Contact resistance: 0.5 mΩ
- Contact material: Copper, tinned, cross-linked

Part No.	Designation	Core cross section mm <sup>2</sup>	Cable Ø mm	Unit Pcs.
905203	PV MC3 female connector 2.5-4/3.2-4.8	2.5 - 4	3.2 - 4.8	50
904956	PV MC3 female connector 2.5-4/4.9-7.1	2.5 - 4	4.9 - 7.1	50

Part No.	Designation	Core cross section mm <sup>2</sup>	Cable Ø mm	Unit Pcs.
905205	PV MC3 female connector 6/4.9-7.1	6	4.9 - 7.1	50
904958	PV MC3 female connector 6/6.5-7.6	6	6.5 - 7.6	50

# PV HC3 male coupling connector



## Technical Data

- Protection classification: IP 67
- Temperature range: -40°C up to +90°C
- Protection type: II
- Rated voltage: 1000 V (IEC)
- Rated current: 20 A (2.5 mm<sup>2</sup> - 4 mm<sup>2</sup>), 30 A (6mm<sup>2</sup>)
- Contact resistance: 0.5 mΩ
- Contact material: Copper, tinned, cross-linked

RoHS

Part No.	Designation	Core cross section mm <sup>2</sup>	Cable Ø mm	Unit Pcs.
905244	PV HC3 male connector 2.5-4/3.2-6	2.5 - 4	3.2 - 6	50
904959	PV HC3 male connector 2.5-4/4.9-8.2	2.5 - 4	4.9 - 7.9	50

Part No.	Designation	Core cross section mm <sup>2</sup>	Cable Ø mm	Unit Pcs.
905246	PV HC3 male connector 6/5.2-7	6	5.2 - 7	50
904961	PV HC3 male connector 6/6.5-9	6	6.5 - 9.1	50

# PV HC3 female coupling connector



## Technical Data

- Protection classification: IP 67
- Temperature range: -40°C up to +90°C
- Protection type: II
- Rated voltage: 1000 V (IEC)
- Rated current: 20 A (2.5 mm<sup>2</sup> - 4 mm<sup>2</sup>), 30 A (6mm<sup>2</sup>)
- Contact resistance: 0.5 mΩ
- Contact material: Copper, tinned, cross-linked

RoHS

Part No.	Designation	Core cross section mm <sup>2</sup>	Cable Ø mm	Unit Pcs.
905245	PV HC3 female connector 2.5-4/3.2-6	2.5 - 4	3.2 - 6	50
904960	PV HC3 female connector 2.5-4/4.9-8.2	2.5 - 4	4.9 - 7.9	50

Part No.	Designation	Core cross section mm <sup>2</sup>	Cable Ø mm	Unit Pcs.
905247	PV HC3 female connector 6/5.2-7	6	5.2 - 7	50
904962	PV HC3 female connector 6/6.5-9	6	6.5 - 9.1	50

# PV Sunclix male coupling connector

**NEW**



## Technical Data

- Protection classification: IP 68
- Temperature range: -40°C up to +90°C (IEC)
- Rated voltage: 1000 A (IEC)
- Rated current: 40 A

Part No.	Designation	Core cross section mm <sup>2</sup>	Cable Ø mm	Unit Pcs.
909165	PV-CM-S	2.5 - 6	3.2 - 4.8	100

# PV Sunclix female coupling connector

**NEW**



## Technical Data

- Protection classification: IP 68
- Temperature range: -40°C up to +90°C (IEC)
- Rated voltage: 1000 A (IEC)
- Rated current: 40 A

Part No.	Designation	Core cross section mm <sup>2</sup>	Cable Ø mm	Unit Pcs.
906166	PV-CF-S	2.5 - 6	3.2 - 4.8	100



# PV MC4 female branch connector



## MC4 female branch connector

For secure and easy connection of PV modules in parallel  
MFF = Male connector/Female connector/Female connector

### Technical data

- Protection classification: IP 67
- Temperature range: -40°C up to +90°C
- Contact material: CuSn
- Casing: PC/PA
- UV-resistant

### Properties

- Easy to assemble
- High degree of strain relief

### Note

- Can be combined with MC4 male/female coupling connector

RoHS

Part No.	Designation	Unit Pcs.
905228	PV MC4 MFF branch	50

# PV MC4 male branch connector



## MC4 male branch connector

For secure and easy connection of PV modules in parallel  
FMM = Female connector/Male connector/Male connector

### Technical data

- Protection classification: IP 67
- Temperature range: -40°C up to +90°C
- Contact material: CuSn
- Casing: PC/PA
- UV-resistant

### Properties

- Easy to assemble
- High degree of strain relief

### Note

- Can be combined with MC4 male/female coupling connector

RoHS

Part No.	Designation	Unit Pcs.
905229	PV MC4 FMM branch	50

# PV MC3 female branch connector



## MC3 female branch connector

For secure and easy connection of PV modules in parallel  
MFF = Male connector/Female connector/Female connector

### Technical data

- Protection classification: IP 67
- Temperature range: -40°C up to +90°C
- Contact material: CuSn
- Casing: TPEPA
- UV resistant

### Properties

- High-quality contact

### Note

- Can be combined with MC3 male/female coupling connector

Part No.	Designation	Unit Pcs.
905226	PV MC3 MFF branch	50

# PV MC3 male branch connector



## MC3 male branch connector

For secure and easy connection of PV modules in parallel  
FMM = Female connector/Male connector/Male connector

### Technical data

- Protection classification: IP 67
- Temperature range: -40°C up to +90°C
- Contact material: CuSn
- Casing: TPEPA
- UV resistant

### Properties

- High-quality contact

### Note

- Can be combined with MC3 male/female coupling connector

Part No.	Designation	Unit Pcs.
905227	PV MC3 FMM branch	50



# Cable accessories

# HELUSOL HS cable gland



RoHS

Part No. Black	Size Metr.	Cable Ø from - to	Thread length mm	Width mm	Unit Pcs.
905241	M 12 x 1.5	3.0 - 6.5	6.0	15	100
905242	M 16 x 1.5	4.5 - 10.0	10.0	18	50

The plastic cable gland with vibration protection. Long-term UV resistance thanks to high-quality material.

## Material

- Halogen-free
- Cadmium-free
- Phosphorous-free
- Shell: PVDF
- Moulded seal: Silicone

## Properties

- Weather and UV resistant
- Optimum strain relief by means of clamping plates
- Easy to assemble
- Large clamping areas

## Technical data

- Protection classification: IP 68 - 5 bar
- Temperature range: -35°C up to +150°C
- Testing standard: EN 50262

# HELUTOP® HT cable gland



RoHS

Part No. Black	Size Metr.	Cable Ø from - to	Thread length mm	Width mm	Unit Pcs.
93937	M 12 x 1.5	3.0 - 6.5	6.0	15	100
92669	M 16 x 1.5	4.5 - 10.0	10.0	18	50
93939	M 20 x 1.5	6.0 - 12.0	10.0	24	50
93940	M 25 x 1.5	11.0 - 17.0	8.0	29	50
93941	M 32 x 1.5	15.0 - 21.0	10.0	36	25
93942	M 40 x 1.5	19.0 - 28.0	10.0	46	20
93943	M 50 x 1.5	28.0 - 38.0	18.0	60	10
93944	M 63 x 1.5	34.0 - 44.0	18.0	65	10

The plastic cable gland with vibration protection.

## Material

- Halogen-free
- Cadmium-free
- Phosphorous-free
- Silicone-free
- Shell: PA
- Black: UV resistant
- Moulded seal: neoprene

## Properties

- Optimum strain relief by means of clamping plates
- Easy to assemble
- Large clamping areas

## Technical data

- Protection classification: IP 68 - 5 bar
- Temperature range: -30°C up to +80°C
- Testing standard: EN 50262

# KMK-PA-MB lock nut



The lock nut made of polyamide. This lock nut featuring a collar has a large contact surface, which makes it easier to create an additional seal with an O-ring.

## Material

- Halogen-free
- Cadmium-free
- Phosphorous-free
- Silicone-free
- PA
- Black: UV resistant

## Properties

- Weather and UV-resistant

## Technical data

- Temperature range: -30°C up to +80°C

RoHS

Part No. Black	Size Metr.	Width mm	Unit Pcs.
98163	M 12 x 1,5	18	100
98164	M 16 x 1,5	22	100
98165	M 20 x 1,5	26	100
98166	M 25 x 1,5	32	100

Part No. Black	Size Metr.	Width mm	Unit Pcs.
98167	M 32 x 1,5	41	100
98168	M 40 x 1,5	50	50
98169	M 50 x 1,5	60	50
98170	M 63 x 1,5	75	25

# HELUcond CO-PA protective tube



The dividable and re-closable cable protective tube for retrofitting cables with a form of mechanical protection.

- Trouble-free retrofitting
- High mechanical strength
- Simple installation of pre-fabricated cables
- Repair of existing systems

## Material

- Halogen-free
- Cadmium-free
- Phosphorous-free
- Polyamide 6
- Black: UV-resistant

## Technical data

- Protection classification: IP 43
- Temperature range: -40°C up to +120°C
- Temperature range for short time: up to +160°C

RoHS

Part No. Black	Nominal size mm	Internal Ø mm	External Ø mm	Unit Pcs.
90061	10.0	8.8	13.5	50
90062	14.0	13.2	18.7	50
90063	20.0	20.0	25.7	50

Part No. Black	Nominal size mm	Internal Ø mm	External Ø mm	Unit Pcs.
90064	23.0	23.9	31.3	50
90065	37.0	32.5	43.2	25

# HELUcond PP-UV

**NEW**



RoHS

Part No.	Nominal size mm	Unit m
906156	10	50
906157	17	50
906158	22	50
906159	23	50
906160	29	25

## Material

- PP-UV
- Colour: black

## Properties

- UV resistant
- Halogen-free
- Chemically resistant to: Acids, bases, inorganic salts, fuels, mineral oils, lubricants, and most commercial solvents

## Technical data

- Temperature range: -40°C up to +105°C
- Flammability according to UL 94 HB

## Note

- Dividable version available on request

Part No.	Nominal size mm	Unit m
906161	37	25
906162	50	25
906163	65	25
906164	75	25

# SK-D shrink-on sleeve thick walled with interior adhesive



RoHS

Part No.	Internal Ø before shrinkage mm	Wall thickness mm	Internal Ø after shrinkage mm	Unit Pcs
905344	8.9	1.8	3.0	1
905335	13.0	2.4	4.1	1
905336	19.1	2.4	6.1	1
905337	27.9	3.0	8.9	1

For the protection of cable sleeves and cable terminations for low voltage applications (600 V).

## Material

- Radiation cross-linked polyolefin with internal adhesive
- Colour: black

## Technical Data

- Temperature range: -55 °C up to +90 °C
- Shrinking temperature: +120 °C
- Shrinking rate: 3:1
- Dielectric strength: 20 kV/mm
- Softening point of the adhesive: +80 °C up to +90 °C

## Note

- Form of shipment: rods, 1.2 m each

Part No.	Internal Ø before shrinkage mm	Wall thickness mm	Internal Ø after shrinkage mm	Unit Pcs
905338	38.1	11.9	4.1	1
905339	50.8	16.0	4.1	1
905340	68.1	22.1	4.1	1

# SK-M shrink-on sleeve medium-thick walled with interior adhesive



Polyolefin shrink-on sleeve with internal adhesive for repairing insulation and sealing electrical components.

## Material

- PO (polyolefin) with internal adhesive
- Flame-retardant
- Colour: black

## Technical data

- Temperature range: -55°C up to +110°C
- Shrinking temperature: +120°C
- Shrinking rate: 3:1

## Note

- Form of shipment: rods, 1.2 m each

RoHS

Part No.	Internal diameter before shrinking mm	Wall thickness mm	Internal diameter after shrinking mm	Unit Pcs.
99788	10.2	2.0	3.8	1
99789	19.0	2.0	5.6	1
99790	28.0	2.0	10.2	1

Part No.	Internal diameter before shrinking mm	Wall thickness mm	Internal diameter after shrinking mm	Unit Pcs.
99792	38.0	2.0	12.7	1
99794	52.0	2.0	19.0	1

# Cable tie type T with plastic lug lock



Cable binder with plastic tongue for directionality and mounting cables and lines.

## Material

- Halogen-free
- Silicone-free
- Polyamide 6.6

## Technical Data

- Temperature range: -40° C up to +80° C
- Flammability according to UL 94 V2

RoHS

Part No. black	Type	Length mm	Width mm	Bundle-Ø mm	Load Capacity N	Unit Pcs.
90130	T2-20	100.0	2.5	20.0	80.0	1000
90131	T2-50	200.0	2.5	50.0	80.0	1000
90132	T3-35	145.0	3.4	35.0	130.0	1000
90133	T3-50	210.0	3.4	50.0	130.0	1000
90134	T3-75	300.0	3.6	75.0	130.0	1000
90137	T5-85	185.0	4.6	50.0	220.0	1000
90136	T5-75	300.0	4.6	75.0	220.0	1000
90148	T5-100	380.0	4.7	100.0	220.0	100
90149	T8-100	365.0	7.6	100.0	540.0	100
96492	T9-165	550.0	9.0	165.0	790.0	100
97223	T9-230	775.0	9.0	230.0	790.0	100

# T-WS



Cable binder with plastic tongue for directionality and mounting cables and lines.

## Material

- Halogen-free
- UV resistant
- Polyamid PA 6.6

## Technische Daten

- Temperature range: -40°C up to +85°C, short-term up to +105°C (500h)
- Flammability acc. to UL 94 V2

Part No. Black	Type Q-Tie®	Length mm	Width mm	Bundle diameter mm	Load rating N	Unit Pcs.
905525	T-WS	100,0	2,5	22,0	80,0	100
905526	T-WS	205,0	2,5	55,0	80,0	100
905527	T-WS	140,0	2,5	35,0	80,0	100
905529	T-WS	150,0	3,5	35,0	135,0	100
905530	T-WS	190,0	3,5	50,0	135,0	100
905531	T-WS	290,0	3,5	80,0	135,0	100
905533	T-WS	200,0	4,6	50,0	225,0	100
905534	T-WS	390,0	4,6	110,0	225,0	100
905536	T-WS	245,0	4,6	65,0	225,0	100
905537	T-WS	300,0	4,7	85,0	355,0	100
905538	T-WS	380,0	7,6	100,0	535,0	100
905539	T-WS	300,0	7,6	80,0	535,0	100
905541	T-WS	460,0	7,6	130,0	535,0	100

# TY-MX cable tie with steel tab - a Thomas & Betts product



## TY-RAP® (UV-stabilised)

TY-RAP® cable tie with steel lug lock made of corrosion-resistant, non-magnetic steel.

Thanks to this technology the cable tie offers excellent binding properties even under the most rigorous conditions such as heat, cold, humidity etc. and is impervious to vibrations and external influences.

## Material

- Halogen-free
- Polyamide 6.6
- Colour: black

## Properties

- UV and ozon resistant

## Technical data

- Temperature range: -40°C up to +85°C
- Flammability according to UL 94 V2

Part No.	Type T & B	Length mm	Width mm	Bundle Ø mm	Load rating N	Unit Pcs.
97310	TY 5-23MX	92.0	2.4	16.0	81	100
97313	TYB 5-24MX	140.0	3.6	29.0	180	100
97436	TY 5-26MX	281.0	3.6	76.0	180	100

Part No.	Type T & B	Length mm	Width mm	Bundle Ø mm	Load rating N	Unit Pcs.
93694	TY 5-26MX	186.0	4.8	45.0	225	100
93696	TY 5-28MX	360.0	4.8	102.0	225	100
93698	TY 5-27MX	338.0	7.6	90.0	544	50





Photo: HELUKABEL®

# Tools

## **Cutting and stripping**

For cutting and stripping solar cables. Can also be used with high-grade sheath material. (Page 34)

## **Crimping and assembling**

The contacts are neatly crimped for the purpose of connecting the solar cables to the connectors. If required, we can also offer specialist assembly accessories. (Page 35 onwards)

# HELUTOOL D20 cable shears



Part No.	Designation	Unit Pcs.
904933	HELUTOOL D20 cable shears	1

## Material

- Special tool steel, forged

## Properties

- For cutting copper and aluminium cables, single-core/multicore
- Minimum effort thanks to efficient transmission ratios and innovative cutting geometry
- Cuts smoothly and cleanly without pinching
- Carves and trims (1st and 2nd blade); capable of cutting through cables up to 25 mm Ø
- Easy cutting with single-handed operation
- Adjustable screwed joint, self-locking

# Stripping pliers for SOLARFLEX®



Part No.	Designation	Unit Pcs.
903572	Stripping pliers for SOLARFLEX®, complete, 1.5 - 6 mm <sup>2</sup>	1
903573	Cutting insert, 1.5 - 6 mm <sup>2</sup>	1
905343	Stripping pliers for SOLARFLEX®, complete, 4 - 10 mm <sup>2</sup>	1
905344	Cutting insert, 4 - 10 mm <sup>2</sup>	1

## Material

- Chromium-plated

## Properties

- For core cross sections of 1.5 - 6 mm<sup>2</sup> or 4 - 10 mm<sup>2</sup>
- With longitudinal stop
- Precise and damage-free stripping
- Exchangeable cutting insert
- Ergonomically shaped two-component handles
- Length 200 mm
- Weight 425 g

# HELUTOOL PEW 12.194 crimping tool



Suitable for crimping turned contacts MC3 and H4

## Properties

- For solderless electrical connections
- Near-parallel crimping action
- Consistently high crimping quality thanks to precision profiles and positive lock (can be released)
- Crimping pressure is set (calibrated) precisely at the factory
- Leverage intensifies force to prevent fatigue when working
- Ergonomically shaped grips
- Various aids for precise positioning
- All stressed parts made from special steel, which is oil-hardened and tempered
- Burnished head, grips fitted with plastic sleeves
- For turned contacts, e.g. MC3
- Length 200 mm
- Weight 570 g

Part No.	Designation	Core cross section mm <sup>2</sup>	Unit Pcs.
906151	HELUTOOL PEW 12.194 for MC3		1
906150	HELUTOOL PEW 12.1194 for H4		1

# PV Tool Box HELUTOOL

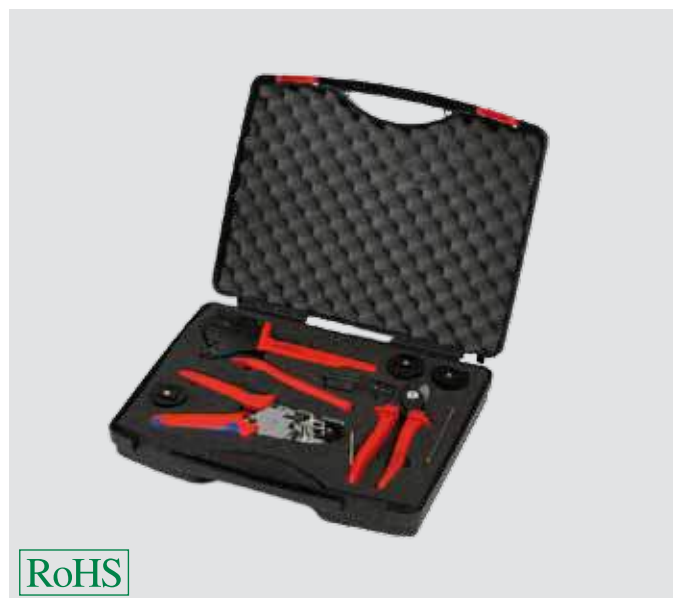

Suitable for mounting MC3, MC4, H4 and other connecting systems (2.5 to 6 mm<sup>2</sup>)

## Content

- Crimping tool PEW with locator (upper and lower part)
- Cable shear, up to 50 mm<sup>2</sup>
- Stripping plier

Other combinations are available on request

Part No.	Designation	Unit Pcs.
906168	PV Tool Box HELUTOOL I for MC3, HC3, H4	1
906169	PV Tool Box HELUTOOL II for MC3, HC3, Tyco, MC4	1

# HELUTOOL PEW 12.570 crimping tool



Suitable for crimping punched contacts MC4

## Properties

- For solderless electrical connections
- Near-parallel crimping action
- Consistently high crimping quality thanks to precision profiles and positive lock (can be released)
- Crimping pressure is set (calibrated) precisely at the factory
- Leverage intensifies force to prevent fatigue when working
- Ergonomically shaped grips
- Various aids for precise positioning
- All stressed parts made from special steel, which is oil-hardened and tempered
- Burnished head, grips fitted with plastic sleeves
- For punched contacts, 2.5 – 6.0 mm<sup>2</sup> (AWG 13 – 10) MC4
- Length 200 mm
- Weight 570 g

Part No.	Designation	Unit Pcs
904971	HELUTOOL PEW 12.570 crimping tool, with locator, 2.5 mm <sup>2</sup> - 6 mm <sup>2</sup>	1
905866	Crimping tool for MC4, with locator, 2.5 mm <sup>2</sup> - 10 mm <sup>2</sup>	1

# HELUTOOL Solar RWZ3 assembly device



For easy assembly of MC3 and HC3 PV couplings

## Properties

- Incl. 2 cones for a cable cross section of 4 and 6 mm<sup>2</sup>
- Length: approx. 34 cm
- Weight: 860 g

Part No.	Designation	Unit Pcs
904968	HELUTOOL Solar RWZ3 assembly device	1
904969	HELUTOOL Solar RWZ3KO I+II replacement cone	1
904970	HELUTOOL Solar RWZ3KO III replacement cone	1

# HELUTOOL Solar MC4 assembly spanner



For easy assembly of PV MC4 couplings

## Properties

- For tightening and releasing the cable gland; for releasing the lock.
- Assembly spanner set

Part No.	Designation	Unit Pcs
904972	HELUTOOL Solar MC4 assembly set, 2.5 - 6 mm <sup>2</sup>	1
9005865	HELUTOOL Solar MC4 assembly set, 10 mm <sup>2</sup>	1

# HELUTOOL Solar H4 assembly spanner

**NEW**



For easy assembly of PV H4 couplings

## Properties

- For tightening and releasing the cable gland; for releasing the lock.
- Assembly spanner set

Part No.	Designation	Unit Pcs
905598	Opener	1
905599	Spanner	1

# Tool - connector combinations

	Part No.	H4			Sunclix			MC3			HC3			MC4				
		2,5 mm <sup>2</sup>	4,0 mm <sup>2</sup>	6,0 mm <sup>2</sup>	2,5 mm <sup>2</sup>	4,0 mm <sup>2</sup>	6,0 mm <sup>2</sup>	2,5 mm <sup>2</sup>	4,0 mm <sup>2</sup>	6,0 mm <sup>2</sup>	2,5 mm <sup>2</sup>	4,0 mm <sup>2</sup>	6,0 mm <sup>2</sup>	10 mm <sup>2</sup>				
Crimping tool	906151	•	•	•				•	•	•	•	•	•					
	906150		•	•	•				•	•		•	•					
	905866	•	•	•	•				•	•	•	•	•					
	904971														•	•	•	•
Stripping pliers	903572	•	•	•		•	•	•	•	•	•	•	•	•	•	•	•	•
	905343		•	•	•							•	•		•	•	•	•

	Part No.	H4	Sunclix	MC3	HC3	MC4
Assembly	904968			•	•	
	904972					•
Cable shears	904933	•	•	•	•	•

# Cable reel HELUTOOL



- For simple reeling of cable drums
- Dynamic brake for constant traction: retarding effect corresponds to the weight bearing on
- Small weight
- Small size
- Can be used with broken rim

RoHS

Part No.	Type	Weight approx. kg	Load capacity kg	Diameter approx. mm	Reel width mm	Units
903716	HELUTOOL 250 pocket	1,00	190	190	-	1
93529	HELUTOOL 190	7,00	380	500	-	1



Photo: HELUKABEL®

# Cables & Wires

**PVC Control Cables** page 40 onwards

**Allweather and Rubber Cable** page 44 onwards

**Power Cables** page 46 onwards

**Installation Cables** page 57

**Medium Voltage Cables** page 58 onwards



RoHS

## Technical Data

- Special PVC control cables Adapted to DIN VDE 0262/12.95 and DIN VDE 0281 part 13, with insulation thickness for 1 kV type
- **Temperature range**  
Flexing -15°C <sup>1)</sup> up to +80°C  
Fixed installation -40°C up to +80°C
- **Nominal voltage** U<sub>0</sub>/U 0,6/1 kV
- **Test voltage** 4000 V
- **Breakdown voltage** min. 8000 V
- **Insulation resistance**  
Min. 20 MΩm x km
- **Power ratings**  
Per DIN VDE 0298
- **Minimum bending radius**  
Flexing 7,5x cable Ø  
Fixed installation 4x cable Ø
- **Radiation resistance**  
Up to 80x10<sup>6</sup> cJ/kg (up to 80 Mrad)  
<sup>1)</sup> cold bending test, impact resistance test at low temperatures, elongation test at low temperatures. Tested acc. to VDE 0473 Teil 811-1-4, EN 60811-1-4

## Cable structure

- Bare copper, fine wire conductors, as per DIN VDE 0295 cl. 5, BS 6360 cl. 5 and IEC 60228 cl. 5
- Special PVC core insulation T12, to DIN VDE 0281 part 1
- Black cores with white figure imprints to DIN VDE 0293
- Green-yellow earth core in the outer layer (3 cores and above)
- Cores stranded in layers with optimal lay-length
- Special PVC outer sheath TM2, to DIN VDE 0281 part 1
- Colour black (RAL 9005)
- With meter marking, change-over in 2011

## Properties

- Extensively oil resistant
- PVC self-extinguishing and flame retardant according to VDE 0482-332-1-2, DIN EN 60332-1-2/ IEC 60332-1 (equivalent DIN VDE 0472 part 804 test method B)
- The materials used in manufacture are cadmium-free and contain no silicone and free from substances harmful to the wetting properties of lacquers
- Resistant to ultra violet ray

## Note

- G = with green-yellow earth core;  
x = without green-yellow earth core (OZ).
- Different dimensions are also available with red resp. blue cores.
- AWG sizes are approximate equivalent values. The actual cross-section is in mm<sup>2</sup>.
- Screened analogue type:  
JZ-600-Y-CY

## Application

Wiring cable for measuring and controlling purposes in tool machinery, conveyor belts and production lines, for plant installations, air conditioning and in steel production plants and rolling mills. Suitable for installation for flexible use for medium mechanical stresses with free movement without tensile stress or forced movements in dry, moist and wet rooms as well as outside (fixed installation). Is not suitable to be used as direct burial- or as underwater cable. The cores have been numbered in such a way that the numbers are easily identifiable, even if the cable has only been stripped back a few cm. The core numbers have been underlined to avoid confusion. The earth core is located in the outer layer. The black, special PVC outer sheath is resistant to the ultra violet radiation. Mainly used in South-European, Eastern and Arabian countries.

CE = The product is conformed with the EC Low-Voltage Directive 2006/95/EG.

Part No.	No. cores x cross-sec. mm <sup>2</sup>	Outer Ø app. mm	Cop. Weight kg / km	Weight app. kg / km	AWG-No.	Part No	No. cores x cross-sec. mm <sup>2</sup>	Outer Ø app. mm	Cop. Weight kg / km	Weight app. kg / km	AWG-No.
10550	2 x 0.5	6.3	9.6	56.0	20	10579	65 G 0.5	24.4	312.0	880.0	20
10551	3 G 0.5	6.6	14.4	68.0	20	10580	80 G 0.5	27.2	384.0	960.0	20
10552	3 x 0.5	6.6	14.4	68.0	20	10581	100 G 0.5	31.2	480.0	1050.0	20
10553	4 G 0.5	7.2	19.0	100.0	20	10582	2 x 0.75	6.6	14.4	66.0	18
10554	4 x 0.5	7.2	19.0	100.0	20	10583	3 G 0.75	6.9	21.6	74.0	18
10555	5 G 0.5	8.0	24.0	117.0	20	10584	3 x 0.75	6.9	21.6	74.0	18
10556	5 x 0.5	8.0	24.0	117.0	20	10585	4 G 0.75	7.5	29.0	126.0	18
10557	6 G 0.5	8.7	29.0	126.0	20	10586	4 x 0.75	7.5	29.0	126.0	18
10558	7 G 0.5	8.7	33.6	138.0	20	10587	5 G 0.75	8.4	36.0	140.0	18
10559	7 x 0.5	8.7	33.6	138.0	20	10588	5 x 0.75	8.4	36.0	140.0	18
10560	8 G 0.5	9.5	38.0	150.0	20	10589	6 G 0.75	9.3	43.0	170.0	18
10561	8 x 0.5	9.5	38.0	150.0	20	10590	6 x 0.75	9.3	43.0	170.0	18
10562	10 G 0.5	10.6	48.0	176.0	20	10591	7 G 0.75	9.3	50.0	190.0	18
10563	12 G 0.5	11.4	58.0	200.0	20	10592	7 x 0.75	9.3	50.0	190.0	18
10564	12 x 0.5	11.4	58.0	200.0	20	10593	8 G 0.75	10.0	58.0	212.0	18
10565	14 G 0.5	12.3	67.0	230.0	20	10594	8 x 0.75	10.0	58.0	212.0	18
10566	16 G 0.5	12.9	76.0	250.0	20	10595	9 G 0.75	10.9	65.0	227.0	18
10567	18 G 0.5	13.8	86.0	276.0	20	10596	10 G 0.75	11.1	72.0	238.0	18
10568	20 G 0.5	14.4	96.0	293.0	20	10597	12 G 0.75	12.2	86.0	257.0	18
10569	21 G 0.5	14.4	96.0	305.0	20	10598	12 x 0.75	12.2	86.0	257.0	18
10570	25 G 0.5	16.1	120.0	335.0	20	10599	14 G 0.75	12.9	101.0	286.0	18
10571	30 G 0.5	17.2	144.0	348.0	20	10600	15 G 0.75	13.8	108.0	319.0	18
10572	32 G 0.5	18.0	154.0	355.0	20	10601	18 G 0.75	14.5	130.0	362.0	18
10573	34 G 0.5	18.7	163.0	520.0	20	10602	20 G 0.75	15.4	144.0	394.0	18
10574	40 G 0.5	19.5	192.0	590.0	20	10603	21 G 0.75	15.4	151.0	422.0	18
10575	42 G 0.5	20.1	202.0	595.0	20	10604	25 G 0.75	17.2	180.0	486.0	18
10576	50 G 0.5	22.1	240.0	715.0	20	10605	32 G 0.75	19.0	230.0	595.0	18
10577	52 G 0.5	22.1	252.0	740.0	20	10606	34 G 0.75	19.9	245.0	638.0	18
10578	61 G 0.5	23.6	293.0	840.0	20	10607	37 G 0.75	19.9	260.0	696.0	18

Dimensions and specifications may be changed without prior notice. (RA01)

Continuation >>



Part No.	No.cores x cross-sec. mm <sup>2</sup>	Outer Ø app. mm	Cop. Weight kg / km	Weight app. kg / km	AWG-No.	Part No.	No.cores x cross-sec. mm <sup>2</sup>	Outer Ø app. mm	Cop. Weight kg / km	Weight app. kg / km	AWG-No.
10608	40 G 0.75	20.6	288.0	726.0	18	10689	2 x 2.5	9.6	48.0	160.0	14
10609	41 G 0.75	20.6	296.0	750.0	18	10690	3 G 2.5	10.1	72.0	175.0	14
10610	42 G 0.75	21.5	302.0	770.0	18	10691	3 x 2.5	10.1	72.0	175.0	14
10611	50 G 0.75	23.7	360.0	895.0	18	10692	4 G 2.5	11.2	96.0	203.0	14
10612	61 G 0.75	25.3	439.0	1070.0	18	10693	4 x 2.5	11.2	96.0	203.0	14
10613	65 G 0.75	26.0	468.0	1110.0	18	10694	5 G 2.5	12.5	120.0	251.0	14
10614	80 G 0.75	28.9	576.0	1500.0	18	10695	5 x 2.5	12.5	120.0	251.0	14
10615	100 G 0.75	33.2	720.0	1889.0	18	10696	7 G 2.5	13.8	168.0	330.0	14
10616	2 x 1	7.0	19.2	80.0	17	10697	7 x 2.5	13.8	168.0	330.0	14
10617	3 G 1	7.4	29.0	96.0	17	10698	8 G 2.5	15.1	192.0	400.0	14
10618	3 x 1	7.4	29.0	96.0	17	10699	12 G 2.5	18.3	288.0	553.0	14
10619	4 G 1	8.2	38.4	100.0	17	10700	14 G 2.5	19.6	336.0	630.0	14
10620	4 x 1	8.2	38.4	100.0	17	10701	18 G 2.5	22.0	432.0	795.0	14
10621	5 G 1	9.2	48.0	130.0	17	10702	21 G 2.5	23.3	504.0	930.0	14
10622	5 x 1	9.2	48.0	130.0	17	10703	25 G 2.5	26.2	600.0	1110.0	14
10623	6 G 1	9.9	58.0	150.0	17	10704	34 G 2.5	30.4	816.0	1450.0	14
10624	7 G 1	9.9	67.0	170.0	17	10705	42 G 2.5	33.0	1008.0	1750.0	14
10625	7 x 1	9.9	67.0	170.0	17	10706	50 G 2.5	36.2	1200.0	2100.0	14
10626	8 G 1	10.9	77.0	230.0	17	10707	61 G 2.5	38.8	1464.0	2540.0	14
10627	9 G 1	11.6	86.0	250.0	17	10708	100 G 2.5	50.2	2400.0	3850.0	14
10628	10 G 1	11.9	96.0	270.0	17	10709	2 x 4	11.1	77.0	180.0	12
10629	10 x 1	11.9	96.0	270.0	17	10710	3 G 4	11.7	115.0	230.0	12
10630	12 G 1	13.1	115.0	290.0	17	10711	4 G 4	13.0	154.0	310.0	12
10631	12 x 1	13.1	115.0	290.0	17	10712	5 G 4	14.5	192.0	410.0	12
10632	14 G 1	14.0	134.0	320.0	17	10713	7 G 4	16.0	269.0	540.0	12
10633	16 G 1	14.8	154.0	360.0	17	10714	8 G 4	17.4	307.0	710.0	12
10634	18 G 1	15.7	173.0	405.0	17	10715	12 G 4	21.4	461.0	860.0	12
10635	18 x 1	15.7	173.0	405.0	17	10716	3 G 6	13.1	173.0	370.0	10
10636	20 G 1	16.7	192.0	450.0	17	10717	4 G 6	14.5	230.0	430.0	10
10637	20 G 1	16.7	192.0	480.0	17	10718	5 G 6	16.2	288.0	650.0	10
10638	21 G 1	16.7	205.0	510.0	17	10719	7 G 6	18.0	403.0	860.0	10
10639	24 G 1	18.4	236.0	550.0	17	10720	3 G 10	16.5	288.0	660.0	8
10640	25 G 1	18.6	240.0	570.0	17	10721	4 G 10	18.2	384.0	790.0	8
10641	25 x 1	18.6	240.0	570.0	17	10722	5 G 10	20.3	480.0	960.0	8
10642	26 G 1	18.8	252.0	590.0	17	10723	7 G 10	22.5	672.0	1300.0	8
10643	30 x 1	19.8	308.0	650.0	17	10724	3 G 16	20.1	461.0	700.0	6
10644	34 G 1	21.5	326.0	750.0	17	10725	4 G 16	22.3	614.0	1100.0	6
10645	36 G 1	21.5	346.0	790.0	17	10726	5 G 16	25.0	768.0	1600.0	6
10646	40 G 1	22.5	384.0	850.0	17	10727	7 G 16	27.4	1075.0	1890.0	6
10647	40 x 1	22.5	384.0	850.0	17	10728	3 G 25	24.8	720.0	1450.0	4
10648	41 G 1	23.2	394.0	890.0	17	10729	4 G 25	27.4	960.0	1600.0	4
10649	42 G 1	23.2	403.0	900.0	17	10730	5 G 25	30.5	1200.0	2050.0	4
10650	50 G 1	25.6	480.0	1100.0	17	10731	7 G 25	33.8	1680.0	2900.0	4
10651	56 G 1	26.4	538.0	1190.0	17	10732	3 G 35	27.1	1008.0	1900.0	2
10652	61 G 1	27.3	586.0	1266.0	17	10733	4 G 35	30.0	1344.0	2400.0	2
10653	65 G 1	28.3	628.0	1560.0	17	10734	5 G 35	33.3	1680.0	2900.0	2
10654	80 G 1	31.4	786.0	1810.0	17	10735	3 G 50	32.4	1440.0	2700.0	1
10655	100 G 1	36.0	960.0	1950.0	17	10736	4 G 50	35.8	1920.0	3400.0	1
10656	2 x 1.5	8.2	29.0	95.0	16	10742	5 G 50	40.0	2400.0	4361.0	1
10657	3 G 1.5	8.6	43.0	112.0	16	10737	3 G 70	36.9	2016.0	3300.0	2/0
10658	3 x 1.5	8.6	43.0	112.0	16	10738	4 G 70	40.9	2688.0	4400.0	2/0
10659	4 G 1.5	9.6	58.0	139.0	16	10743	5 G 70	45.5	3360.0	5807.0	2/0
10660	4 x 1.5	9.6	58.0	139.0	16	10739	3 G 95	41.7	2736.0	5050.0	3/0
10661	5 G 1.5	10.7	72.0	170.0	16	10740	4 G 95	46.2	3648.0	6010.0	3/0
10662	5 x 1.5	10.7	72.0	170.0	16	10744	5 G 95	51.7	4560.0	7752.0	3/0
10663	6 G 1.5	11.6	86.0	190.0	16	10741	4 G 120	51.6	4608.0	7500.0	4/0
10664	7 G 1.5	11.6	101.0	225.0	16	10745	4 G 150	58.5	5760.0	8640.0	300 kcmil
10665	7 x 1.5	11.6	101.0	225.0	16	10746	4 G 185	61.1	7104.0	10380.0	350 kcmil
10666	8 G 1.5	13.8	115.0	250.0	16						
10667	9 G 1.5	15.2	130.0	280.0	16						
10668	10 G 1.5	15.2	144.0	300.0	16						
10669	11 G 1.5	15.5	158.0	330.0	16						
10670	12 G 1.5	15.5	173.0	370.0	16						
10671	12 x 1.5	15.5	173.0	370.0	16						
10672	14 G 1.5	16.6	202.0	400.0	16						
10673	16 G 1.5	17.5	230.0	450.0	16						
10674	18 G 1.5	18.6	259.0	520.0	16						
10675	19 G 1.5	18.6	279.0	550.0	16						
10676	20 G 1.5	19.7	288.0	600.0	16						
10677	21 G 1.5	20.6	302.0	600.0	16						
10678	25 G 1.5	22.5	360.0	730.0	16						
10679	32 G 1.5	24.5	461.0	880.0	16						
10680	34 G 1.5	25.6	490.0	950.0	16						
10681	40 G 1.5	26.7	576.0	990.0	16						
10682	42 G 1.5	27.6	605.0	1120.0	16						
10683	50 G 1.5	30.4	720.0	1400.0	16						
10684	56 G 1.5	31.5	806.0	1530.0	16						
10685	61 G 1.5	32.6	878.0	1700.0	16						
10686	65 G 1.5	34.8	936.0	1900.0	16						
10687	80 G 1.5	37.4	1152.0	2300.0	16						
10688	100 G 1.5	41.6	1440.0	2700.0	16						

Dimensions and specifications may be changed without prior notice. (RA01)

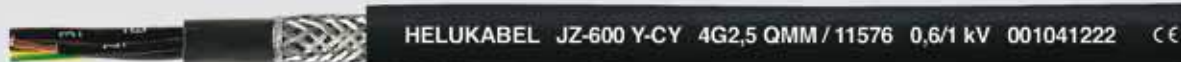

### Technical Data

- Special control cables with thermoplastic PVC insulation On the basis of DIN VDE 0262/12.95 and DIN VDE 0281 part 13
- **Temperature range**  
Flexing -15°C <sup>1)</sup> up to +80°C  
Fixed installation -40°C up to +90°C
- **Nominal voltage** U<sub>0</sub>/U 0,6/1 kV
- **Test voltage** 4000 V
- **Breakdown voltage** min. 8000 V
- **Insulation resistance**  
Min. 20 MΩ x km
- **Power rating**  
According to DIN VDE 0298
- **Minimum bending radius**  
Flexing 10x cable Ø  
Fixed installation 5x cable Ø
- **Radiation resistance**  
Up to 80x10<sup>6</sup> cJ/kg (up to 80 Mrad)
- **Coupling resistance**  
Max. 250 Ω/km
- <sup>1)</sup> cold bending test, impact resistance test at low temperatures, elongation test at low temperatures. Tested acc. to VDE 0473 Teil 811-1-4, EN 60811-1-4

### Cable structure

- Bare copper, fine wire conductors, according to DIN VDE 0295 cl. 5, BS 6360 cl. 5 and IEC 60228 cl. 5
- Special PVC core insulation TI2, to DIN VDE 0281 part 1
- Black cores with sequential numbering imprinted in white, according to DIN VDE 0293
- Green-yellow earth core in the outer layer (3 cores and above)
- Cores stranded in layers with optimal lay-length
- PVC-insulated inner sheath
- Braided screen of tinned Cu wires, coverage approx. 85%
- Special PVC outer sheath TM2, to DIN VDE 0281 part 1
- Colour black (RAL 9005)
- With meter marking, change-over in 2011

### Properties

- Extensively oil resistant
- PVC self-extinguishing and flame retardant according to VDE 0482-332-1-2, DIN EN 60332-1-2/ IEC 60332-1 (equivalent DIN VDE 0472 part 804 test method B)
- The materials used in manufacture are cadmium-free and contain no silicone and free from substances harmful to the wetting properties of lacquers
- Resistant to ultra violet rays

### Note

- G = with green-yellow earth core;  
x = without green-yellow earth core (OZ).
- Further sizes are available upon request.
- AWG sizes are approximate equivalent values. The actual cross-section is in mm<sup>2</sup>.
- Unscreened analogue type:  
JZ-600

### Application

Wiring cable for measuring and controlling purposes in tool machinery, conveyor belts and production lines, for plant installations, air conditioning and in steel production plants and rolling mills. Suitable for installation for flexible use for medium mechanical stresses with free movement without tensile stress or forced movements in dry, moist and wet rooms as well as outside (fixed installation). Is not suitable to be used as direct burial- or as underwater cable. The cores have been numbered in such a way that the numbers are easily identifiable, even if the cable has only been stripped back a few cm. The core numbers have been underlined to avoid confusion. The earth core is located in the outer layer. The black, special PVC outer sheath is resistant to the ultra violet radiation. Mainly used in South-European, Eastern and Arabian countries. Interference-free transmission of signals and pulses is assured by the high degree of screening.

**EMC** = Electromagnetic compatibility

To optimise the EMC features we recommend a large round contact of the copper braiding on both ends.

**CE** = The product is conformed with the EC Low-Voltage Directive 2006/95/EG.

Part No.	No. cores x cross-sec. mm <sup>2</sup>	Outer Ø app. mm	Cop. Weight kg / km	Weight app. kg / km	AWG-No.	Part No.	No. cores x cross-sec. mm <sup>2</sup>	Outer Ø app. mm	Cop. Weight kg / km	Weight app. kg / km	AWG-No.
11464	2 x 0.5	8.5	41.0	129.0	20	11516	2 x 1	9.4	54.0	150.0	17
11465	3 G 0.5	8.8	45.0	150.0	20	11517	3 G 1	9.8	64.0	163.0	17
11466	4 G 0.5	9.6	54.0	170.0	20	11518	4 G 1	10.6	76.0	200.0	17
11467	5 G 0.5	10.2	66.0	199.0	20	11519	5 G 1	11.4	89.0	239.0	17
11469	7 G 0.5	11.1	79.0	235.0	20	11521	7 G 1	12.5	114.0	289.0	17
11472	12 G 0.5	14.0	137.0	320.0	20	11525	12 G 1	15.7	186.0	464.0	17
11475	18 G 0.5	16.2	156.0	428.0	20	11528	18 G 1	18.4	284.0	628.0	17
11478	25 G 0.5	19.1	250.0	503.0	20	11532	25 G 1	21.6	387.0	855.0	17
11489	2 x 0.75	8.8	46.0	143.0	18	11546	2 x 1.5	10.6	64.0	162.0	16
11490	3 G 0.75	9.3	57.0	155.0	18	11547	3 G 1.5	11.1	82.0	187.0	16
11491	4 G 0.75	9.9	63.0	190.0	18	11548	4 G 1.5	11.8	99.0	240.0	16
11492	5 G 0.75	10.8	76.0	228.0	18	11549	5 G 1.5	13.1	123.0	289.0	16
11494	7 G 0.75	11.5	100.0	323.0	18	11551	7 G 1.5	14.2	148.0	383.0	16
11498	12 G 0.75	14.8	175.0	410.0	18	11556	12 G 1.5	18.1	274.0	592.0	16
11501	18 G 0.75	17.1	240.0	560.0	18	11559	18 G 1.5	21.4	386.0	806.0	16
11504	25 G 0.75	20.2	306.0	730.0	18	11563	25 G 1.5	24.9	531.0	1241.0	16

Dimensions and specifications may be changed without prior notice. (RA01)

Continuation »

# JZ-600-Y-CY

PVC control cable, flexible, UV-resistant, number coded, Cu-screened



Part No.	No. cores x cross-sec. mm <sup>2</sup>	Outer Ø app. mm	Cop. Weight kg / km	Weight app. kg / km	AWG-No.	Part No.	No. cores x cross-sec. mm <sup>2</sup>	Outer Ø app. mm	Cop. Weight kg / km	Weight app. kg / km	AWG-No.
11574	2 x 2.5	12.1	110.0	272.0	14	11610	5 G 16	27.0	940.0	2720.0	6
11575	3 G 2.5	12.7	148.0	298.0	14	11611	7 G 16	29.7	1345.0	3213.0	6
11576	4 G 2.5	13.8	169.0	345.0	14						
11577	5 G 2.5	15.1	220.0	427.0	14	11612	3 G 25	26.9	920.0	2465.0	4
11578	7 G 2.5	16.6	284.0	561.0	14	11613	4 G 25	29.7	1169.0	2750.0	4
11580	12 G 2.5	21.3	470.0	857.0	14	11614	5 G 25	33.0	1420.0	3490.0	4
11582	18 G 2.5	25.4	572.0	1355.0	14	11615	7 G 25	36.4	1921.0	4980.0	4
11584	25 G 2.5	29.6	740.0	1995.0	14						
						11616	3 G 35	29.2	1250.0	3230.0	2
11590	2 x 4	13.8	124.0	306.0	12	11617	4 G 35	21.5	1680.0	4100.0	2
11591	3 G 4	14.4	178.0	391.0	12	11618	5 G 35	36.1	2020.0	4950.0	2
11592	4 G 4	15.7	234.0	527.0	12						
11593	5 G 4	17.3	284.0	700.0	12	11619	3 G 50	34.9	1887.0	4590.0	1
11594	7 G 4	19.0	321.0	920.0	12	11620	4 G 50	38.7	2370.0	5780.0	1
11596	12 G 4	24.4	581.0	1510.0	12	11621	5 G 50	43.2	2880.0	7210.0	1
						11622	3 G 70	39.8	2516.0	5610.0	2/0
11597	2 x 6	15.2	176.0	420.0	10	11623	4 G 70	44.0	3257.0	7480.0	2/0
11598	3 G 6	15.9	245.0	629.0	10	11624	5 G 70	48.4	4032.0	9390.0	2/0
11599	4 G 6	17.3	316.0	731.0	10						
11600	5 G 6	19.2	442.0	1105.0	10	11625	3 G 95	44.4	3086.0	8585.0	3/0
11601	7 G 6	21.0	530.0	1465.0	10	11626	4 G 95	48.6	4060.0	10220.0	3/0
						11627	5 G 95	53.7	5244.0	13800.0	3/0
11602	2 x 10	18.6	260.0	845.0	8						
11603	3 G 10	19.7	367.0	1125.0	8	11628	3 G 120	51.9	4176.0	11105.0	4/0
11604	4 G 10	21.5	549.0	1345.0	8	11629	4 G 120	53.3	5231.0	13750.0	4/0
11605	5 G 10	23.7	604.0	1635.0	8						
11606	7 G 10	26.0	820.0	2210.0	8	13137	4 G 150	61.2	7760.0	15990.0	300 kcmil
11607	2 x 16	21.6	491.0	1150.0	6	13147	4 G 185	64.4	8104.0	18470.0	350 kcmil
11608	3 G 16	22.7	653.0	1395.0	6						
11609	4 G 16	24.3	807.0	1870.0	6						

Dimensions and specifications may be changed without prior notice. (RA01)



Photo: Solar plant on open land



## Technical Data

- Rubber sheathed cable H07 RN-F to DIN VDE 0282 part 4, HD 22.4 S4, BS7919 = IEC 60245-4
- **Temperature range**  
-30°C up to +60°C
- Permissible **operating temperature** at conductor +60°C
- **Nominal voltage**  $U_0/U$  450/750 V in case of protected and fixed installation  $U_0/U$  600/1000 V
- Max. permissible **operating voltage** in three phase and one phase a.c. system  $U_0/U$  476/825 V
- Direct current-system  $U_0/U$  619/1238 V
- **Test voltage** 2500 V
- **Permanent tensile load**  
max. 15 N/mm<sup>2</sup>
- **Minimum bending radius**  
For fixed installation 4x cable  $\emptyset$   
For guiding over roller 7,5x cable  $\emptyset$   
During winding on drums 5-7x cable  $\emptyset$

## Cable structure

- Copper conductor fine wire stranded, bare to DIN VDE 0295 cl. 5, BS 6360 cl. 5, IEC 60228 cl. 5 and HD 383
- Rubber core insulation EI4 to DIN VDE 0282 part 1
- Insulation thickness to DIN VDE 0282 part 4
- Core identification to DIN VDE 0293-308
- Core colours
- Up to 5 cores one-coloured
- 6 and more cores, black with numbering
- 3 and above, with green-yellow earth core
- 2 cores without green-yellow earth core
- Cores stranded in layers with optimal lay-length
- Outer jacket of rubber black, rubber compound to DIN VDE 0282 part 1
- Sheath thickness to DIN VDE 0282 part 4

## Properties

- Resistant to Weather
- **Test**  
Test according to VDE 0482-332-1-2, DIN EN 60332-1-2/ IEC 60332-1 (equivalent DIN VDE 0472 part 804 test method B)
- Oil resistant  
Test according to EN 60811-2-1

## Note

- G = with green-yellow earth core  
x = without green-yellow earth core
- AWG sizes are approximate equivalent values, the actual cross-section is in mm<sup>2</sup>.
- Further dimensions and cross-sections available on request
- H07 RN-F = harmonized rubber-sheathed cable, working voltage 750 V, fine stranded.
- The core identification of a single core jacketed, of an insulated wire is black
- For application as a protective core, the ends are to be identified with green-yellow and the middle conductor with light blue

## Application

Heavy duty rubber-sheathed flexible cables are suited for use for medium mechanical stress in dry, damp and wet areas as well as in open air and in agriculture plants.

They are used for equipment in industry works such as boilers, heating plates, hand lamps, electric tools such as drills, circular saws and homework tools as well as for transportable motors or machines at site.

These cables are also suitable for fixed installation on plaster, in temporary buildings and residential barracks. They are suitable for direct laying on components and mechanical parts of machines, for example lifts and cranes.

They can be used in case of protected and fixed installation in tubes or in equipment as well as rotor connecting cable of motors with a working voltage up to 1000 V alternating voltage or a direct voltage up to 750 V against ground. The operating direct voltage is permitted up to 900 V against ground when they are used in rail-coaches. Installation in hazardous areas according to DIN VDE 0165 is allowed.

CE = The product is conformed with the EC Low-Voltage Directive 2006/95/EG.

Part No.	No. cores x cross-sec. mm <sup>2</sup>	Outer $\emptyset$ min. - max. mm	Cop. Weight kg / km	Weight app. kg / km	AWG-No.	Part No.	No. cores x cross-sec. mm <sup>2</sup>	Outer $\emptyset$ min. - max. mm	Cop. Weight kg / km	Weight app. kg / km	AWG-No.
37001	1 x 1.5	5.7 - 7.1	14.4	58.0	16	37019	2 x 1	7.7 - 10.0	19.0	98.0	17
37002	1 x 2.5	6.3 - 7.9	24.0	71.0	14	37020	2 x 1.5	8.5 - 11.0	29.0	135.0	16
37003	1 x 4	7.2 - 9.0	38.0	100.0	12	37021	2 x 2.5	10.2 - 13.1	48.0	193.0	14
37004	1 x 6	7.9 - 9.8	58.0	130.0	10	37022	2 x 4	11.8 - 15.1	77.0	280.0	12
37005	1 x 10	9.5 - 11.9	96.0	230.0	8	37023	2 x 6	13.1 - 16.8	115.0	330.0	10
37006	1 x 16	10.8 - 13.4	154.0	290.0	6	37024	2 x 10	17.7 - 22.6	192.0	586.0	8
37007	1 x 25	12.7 - 15.8	240.0	420.0	4	37025	2 x 16	20.2 - 25.7	307.0	810.0	6
37008	1 x 35	14.3 - 17.9	336.0	530.0	2	37026	2 x 25	24.3 - 30.7	480.0	1160.0	4
37009	1 x 50	16.5 - 20.6	480.0	750.0	1						
37010	1 x 70	18.6 - 23.3	672.0	960.0	2/0						
37011	1 x 95	20.8 - 26.0	912.0	1250.0	3/0						
37012	1 x 120	22.8 - 28.6	1152.0	1560.0	4/0						
37013	1 x 150	25.2 - 31.4	1440.0	1900.0	300 kcmil						
37014	1 x 185	27.6 - 34.4	1776.0	2300.0	350 kcmil						
37015	1 x 240	30.6 - 38.3	2304.0	2950.0	500 kcmil						
37016	1 x 300	33.5 - 41.9	2880.0	3600.0	600 kcmil						
37017	1 x 400	37.4 - 46.8	3840.0	4600.0	750 kcmil						
37018	1 x 500	41.3 - 52.0	4800.0	6000.0	1000 kcmil						

Dimensions and specifications may be changed without prior notice. (RF01)

Continuation »

Part No.	No. cores x cross-sec. mm <sup>2</sup>	Outer Ø min. - max. mm	Cop. Weight kg / km	Weight app. kg / km	AWG-No.	Part No.	No. cores x cross-sec. mm <sup>2</sup>	Outer Ø min. - max. mm	Cop. Weight kg / km	Weight app. kg / km	AWG-No.
37027	3G1	8.3 - 10.7	29.0	130.0	17	37061	5 G 1.5	11.2 - 14.4	72.0	240.0	16
37028	3G1.5	9.2 - 11.9	43.0	165.0	16	37062	5 G 2.5	13.3 - 17.0	120.0	345.0	14
37029	3G2.5	10.9 - 14.0	72.0	235.0	14	37063	5 G 4	15.6 - 19.9	192.0	485.0	12
37030	3G4	12.7 - 16.2	115.0	320.0	12	37064	5 G 6	17.5 - 22.2	288.0	650.0	10
37031	3G6	14.1 - 18.0	173.0	420.0	10	37065	5 G 10	22.9 - 29.1	480.0	1200.0	8
37032	3G10	19.1 - 24.2	288.0	810.0	8	37066	5 G 16	26.4 - 33.3	768.0	1550.0	6
37033	3G16	21.8 - 27.6	461.0	1050.0	6	37067	5 G 25	32.0 - 40.4	1200.0	2250.0	4
37034	3G25	26.1 - 33.0	720.0	1250.0	4	37068	5 G 35	36.8 - 45.8	1680.0	2750.0	2
37035	3G35	29.3 - 37.1	1008.0	1900.0	2	37091	5 G 50	40.0 - 50.8	2400.0	3950.0	1
37036	3G50	34.1 - 42.9	1440.0	2600.0	1	37154	5 G 70	43.8 - 54.0	3360.0	4740.0	1
37037	3G70	38.4 - 48.3	2016.0	3400.0	2/0	34090	5 G 95	51.7 - 60.7	4560.0	6600.0	3/0
37038	3G95	43.3 - 54.0	2736.0	4450.0	3/0	34349	5 G 120				
37039	3G120	47.4 - 60.0	3456.0	5180.0	470						
37040	3G150	52.0 - 66.0	4320.0	6500.0	300 kcmil	37092	7 G 1.5	14.5 - 17.5	101.0	375.0	16
37041	3G185	57.0 - 72.0	5328.0	7860.0	350 kcmil	37079	7 G 2.5	16.5 - 20.0	168.0	520.0	14
37042	3G240	65.0 - 82.0	6192.0	10224.0	500 kcmil						
37043	3G300	72.0 - 90.0	8640.0	12620.0	600 kcmil	37093	12 G 1.5	17.6 - 22.4	175.0	460.0	16
						37096	12 G 2.5	20.6 - 26.2	288.0	760.0	14
37044	4G1	9.2 - 11.9	38.0	150.0	17						
37045	4G1.5	10.2 - 13.1	58.0	200.0	16	37097	18 G 2.5	24.4 - 30.9	432.0	850.0	14
37046	4G2.5	12.1 - 15.5	96.0	290.0	14						
37047	4G4	14.0 - 17.9	154.0	395.0	12	37094	19 G 1.5	20.7 - 26.3	274.0	810.0	16
37048	4G6	15.7 - 20.0	230.0	540.0	10	37098	19 G 2.5	25.5 - 31.0	456.0	1075.0	14
37049	4G10	20.9 - 26.5	384.0	950.0	8						
37050	4G16	23.8 - 30.1	614.0	1260.0	6						
37051	4G25	28.9 - 36.6	960.0	1860.0	4	37095	24 G 1.5	24.3 - 30.7	346.0	1015.0	16
37052	4G35	32.5 - 41.1	1344.0	2380.0	2	37099	24 G 2.5	28.8 - 36.4	576.0	1390.0	14
37053	4G50	37.7 - 47.5	1920.0	3190.0	1						
37054	4G70	42.7 - 54.0	2688.0	4260.0	2/0						
37055	4G95	48.4 - 61.0	3648.0	5600.0	3/0						
37056	4G120	53.0 - 66.0	4608.0	6830.0	4/0						
37057	4G150	58.0 - 73.0	5760.0	8320.0	300 kcmil						
37058	4G185	64.0 - 80.0	7104.0	9800.0	350 kcmil						
37059	4G240	72.0 - 91.0	9216.0	12100.0	500 kcmil						
37060	4G300	80.0 - 101.0	11520.0	15200.0	600 kcmil						

Dimensions and specifications may be changed without prior notice. (RF01)

## Current ratings for H07 RN-F for current supply in industrial application

Operating temperature at conductor 60° C; Ambient temperature 30° C (Air)

Number of cores	1-core		2-cores	3-cores	3-cores	4-cores	5-cores
	2 cores loaded	3 cores loaded	2 cores loaded	2 cores loaded	3 cores loaded	3 cores loaded	3 cores loaded
Number of loaded cores							
Cross-section, mm <sup>2</sup>	Current ratings in Ampere (A)						
4	34	30	34	35	29	30	30
6	43	38	43	44	36	37	38
10	60	53	60	62	51	52	54
16	79	71	79	82	67	69	71
25	104	94	105	109	89	92	94
35	129	117	-	135	110	114	-
50	162	148	-	169	138	143	-
70	202	185	-	211	172	178	-
95	240	222	-	250	204	210	-
120	280	260	-	292	238	246	-
150	321	300	-	335	273	282	-
185	363	341	-	378	309	319	-
240	433	407	-	447	365	377	-
300	497	468	-	509	415	430	-
400	586	553	-	-	-	-	-
500	670	634	-	-	-	-	-
630	784	742	-	-	-	-	-

### Note

For method installation

Single core cables are bunched (unit-form) / 2 cores cables laid parallel with contact / 3 cores cables are in triangled form

### Conversion factors for deviating ambient temperature

Ambient temperature at air ° C	30	35	40	45	50	55
Factor	1.0	0.91	0.82	0.71	0.58	0.41



## Technical Data

- Power and control cable to DIN VDE 0276 part 603 S1, HD 603.1 and IEC 60502, 7 core and above to DIN VDE 0276 part 627, HD 627 S1 and IEC 60502
- **Temperature range**  
flexing -5°C up to +50°C  
fixed installation -40°C up to +70°C
- Permissible **operating temperature** at conductor +70°C
- Permissible **short circuit temperature** +160°C (short circuit duration 5 sec.)
- **Nominal voltage**  $U_0/U$  0.6/1 kV
- **Test voltage** 4 kV
- Max. permissible **tensile stress** with cable grip for Cu-conductor = 50 N/mm<sup>2</sup>
- **Minimum bending radius**  
for single core approx. 15x cable Ø  
for multi core approx. 12x cable Ø

## Cable structure

- Plain copper conductor, to DIN VDE 0295 cl. 1 or cl. 2 solid or stranded type, BS 6360 cl. 1 or cl. 2, IEC 60228 and HD 383
- PVC core insulation, DIV4 to HD 603.1
- Cores stranded concentrically
- Colour coded to DIN VDE 0293-308, 0276 part 603 or HD 186
- Core colour for 3+½ conductor
- J-type: gnye (½), bn, bk, gy
- O-type: bu (½), bn, bk, gy
- PVC outer jacket, DMV5 to HD 603.1
- Sheath colour black

## Properties

- PVC self-extinguishing and flame retardant according to VDE 0482-332-1-2, DIN EN 60332-1-2/ IEC 60332-1 (equivalent DIN VDE 0472 part 804 test method B)
- The materials used in manufacture are cadmium-free and contain no silicone and free from substances harmful to the wetting properties of lacquers
- **Highest permissible voltage**
- Direct current systems 1.8 kV
- Alternating current systems, single-phase systems 1.4 kV  
Both conductors insulated, single-phase systems 0.7 kV  
One conductor earthed, three-phase systems 1.2 kV  
With concentric conductor and a cross-section of 240 mm<sup>2</sup> and above 3.6 kV

## Note

- re = round conductor, single-wire;  
rm = round conductor, multiple-wire;  
sm = stranded, sectional core.
- Also available in NYFGBY, NYBY versions etc.
- 2 cores = adapted to DIN VDE.
- **In respect to 3+½ conductors**  
Whereby only one conductor is allowed to contain a smaller cross-section (as per DIN VDE 0276 part 603 table 5) and permitted to place as insulated core (green-yellow and blue as ½-conductor), stranded in layer.

## Application

Power cables for energy supply are installed in open air, in underground, in water, indoors, in cable ducts, power stations, for industry and distribution boards as well as in subscriber networks, where mechanical damages are not to be expected.

☑ = The product is conformed with the EC Low-Voltage Directive 2006/95/EG.

No. cores x cross-sec. mm <sup>2</sup>	Outer Ø app. mm	Cop. Weight kg / km	Weight app. kg / km	J-type Part No.	AWG-No.	O-type Part No.	AWG-No.
1x 4 re	9.0	38	115	32001	12	32089	12
1x 6 re	9.5	58	135	32002	10	32090	10
1x 10 re	10.0	96	179	32003	8	32091	8
1x 16 re	11.0	154	245	32004	6	32092	6
1x 25 rm	12.0	240	360	32005	4	32093	4
1x 35 rm	13.0	336	470	32006	2	32094	2
1x 50 rm	15.0	480	620	32007	1	32095	1
1x 70 rm	16.5	672	810	32008	2/0	32096	2/0
1x 95 rm	19.0	912	1110	32009	3/0	32097	3/0
1x 120 rm	20.5	1152	1360	32010	4/0	32098	4/0
1x 150 rm	22.5	1440	1670	32011	300 kcmil	32099	300 kcmil
1x 185 rm	25.0	1776	2050	32012	350 kcmil	32100	350 kcmil
1x 240 rm	28.0	2304	2630	32013	500 kcmil	32101	500 kcmil
1x 300 rm	30.0	2880	3200	32014	600 kcmil	32102	600 kcmil
1x 400 rm	34.0	3840	4150	32015	750 kcmil	32103	750 kcmil
1x 500 rm	38.0	4800	5200	32556	1000 kcmil	32558	1000 kcmil
1x 630 rm	43.0	6048	6650	32557		32559	

No. cores x cross-sec. mm <sup>2</sup>	Outer Ø app. mm	Cop. Weight kg / km	Weight app. kg / km	J-type Part No.	AWG-No.	O-type Part No.	AWG-No.
2 x 1.5 re	11.0	29	175	32016	16	32104	16
2 x 2.5 re	12.0	48	215	32017	14	32105	14
2 x 4 re	14.0	77	295	32018	12	32106	12
2 x 6 re	15.0	115	370	32019	10	32107	10
2 x 10 re	16.5	192	495	32020	8	32108	8
2 x 16 re	18.5	307	670	32021	6	32109	6
2 x 25 rm	23.5	480	960	32022	4	32110	4
3 x 1.5 re	11.5	43	195	32023	16	32111	16
3 x 2.5 re	12.5	72	250	32024	14	32112	14
3 x 4 re	14.0	115	340	32025	12	32113	12
3 x 6 re	15.0	173	430	32026	10	32114	10
3 x 10 re	17.0	288	590	32027	8	32115	8
3 x 16 re	19.0	461	820	32028	6	32116	6
3 x 25 rm	24.0	720	1320	32029	4	32117	4
3 x 35 sm	25.0	1008	1450	32030	2	32118	2
3 x 50 sm	26.5	1440	1850	32031	1	32119	1
3 x 70 sm	30.0	2016	2450	32032	2/0	32120	2/0
3 x 95 sm	34.5	2736	3300	32033	3/0	32121	3/0
3 x 120 sm	37.0	3456	4100	32034	4/0	32122	4/0
3 x 150 sm	40.0	4320	4900	32293	300 kcmil	32296	300 kcmil
3 x 185 sm	46.0	5328	6500	32294	350 kcmil	32297	350 kcmil
3 x 240 sm	51.0	6912	8300	32295	500 kcmil	32298	500 kcmil
4 x 1.5 re	12.0	58	230	32044	16	32132	16
4 x 2.5 re	13.5	96	300	32045	14	32133	14
4 x 4 re	15.0	154	410	32046	12	32134	12
4 x 6 re	16.5	230	520	32047	10	32135	10
4 x 10 re	18.5	384	730	32048	8	32136	8
4 x 16 re	21.5	614	1045	32049	6	32137	6
4 x 25 rm	26.0	960	1640	32050	4	32138	4
4 x 35 sm	27.5	1344	1760	32051	2	32139	2
4 x 50 sm	30.0	1920	2350	32052	1	32140	1
4 x 70 sm	34.0	2688	3100	32053	2/0	32141	2/0
4 x 95 sm	39.0	3648	4250	32054	3/0	32142	3/0
4 x 120 sm	42.5	4608	5300	32055	4/0	32143	4/0
4 x 150 sm	47.5	5760	6400	32056	300 kcmil	32144	300 kcmil
4 x 185 sm	52.0	7104	8500	32057	350 kcmil	32145	350 kcmil
4 x 240 sm	58.0	9216	11000	32058	500 kcmil	32146	500 kcmil
5 x 1.5 re	13.0	72	270	32059	16	32147	16
5 x 2.5 re	14.5	120	360	32060	14	32148	14
5 x 4 re	16.5	192	490	32061	12	32149	12
5 x 6 re	18.0	288	600	32062	10	32150	10
5 x 10 re	20.0	480	890	32063	8	32151	8
5 x 16 re	22.5	768	1255	32064	6	32152	6
5 x 25 rm	28.0	1200	1960	32065	4		
5 x 35 rm	34.0	1680	2400	32300	2		
5 x 50 rm	40.0	2400	3500	32257	1		
7 x 1.5 re	15.5	101	310	32066	16	32153	16
7 x 2.5 re	16.5	168	450	32076	14		
7 x 4 re	18.5	269	640	32086	12		
7 x 6 re	20.0	403	850	32087	10	32174	10
7 x 10 re	23.5	672	1200	32088	8	32175	8
10 x 1.5 re	18.0	144	380	32067	16	32154	16
10 x 2.5 re	19.5	240	520	32077	14		
12 x 1.5 re	19.0	173	420	32068	16	32155	16
12 x 2.5 re	20.5	288	600	32078	14		
14 x 1.5 re	20.0	202	470	32069	16	32156	16
14 x 2.5 re	21.0	336	680	32079	14		
16 x 1.5 re	21.0	230	520	32070	16	32157	16
16 x 2.5 re	22.0	384	750	32080	14		
19 x 1.5 re	22.0	274	570	32071	16	32158	16
19 x 2.5 re	23.0	456	850	32081	14		
21 x 1.5 re	23.0	302	650	32072	16	32159	16
21 x 2.5 re	24.5	504	980	32082	14		
24 x 1.5 re	25.0	346	750	32073	16	32160	16
24 x 2.5 re	27.0	576	1100	32083	14		
30 x 1.5 re	26.0	432	860	32074	16	32161	16
30 x 2.5 re	28.0	720	1280	32084	14		
40 x 1.5 re	29.0	576	1070	32075	16	32162	16
40 x 2.5 re	31.5	960	1700	32085	14		
52 x 2.5 re	35.0	1248	2150	32169	14		
61 x 1.5 re	34.0	878	1680	32176	16		

## 3+½-conductors

No. cores x cross-sec. mm <sup>2</sup>	Outer Ø app. mm	Cop. Weight kg / km	Weight app. kg / km	J-type Part No.	AWG-No.	O-type Part No.	AWG-No.
3 x 25 / 16 rm	24.5	874	1530	32035	4	32123	4
3 x 35 / 16 sm	26.0	1162	1750	32036	2	32124	2
3 x 50 / 25 sm	29.0	1680	2350	32037	1	32125	1
3 x 70 / 35 sm	32.0	2352	2850	32038	2/0	32126	270
3 x 95 / 50 sm	38.0	3216	3850	32039	3/0	32127	3/0
3 x 120 / 70 sm	41.0	4128	4780	32040	4/0	32128	4/0
3 x 150 / 70 sm	46.0	4992	5800	32041	300 kcmil	32129	300 kcmil
3 x 185 / 95 sm	51.0	6240	7600	32042	350 kcmil	32130	350 kcmil
3 x 240 / 120 sm	58.0	8064	9800	32043	500 kcmil	32131	500 kcmil
3 G 300 / 150 sm	64.0	10080	11500	32256	600 kcmil		

Dimensions and specifications may be changed without prior notice. (RQ01)



## Technical Data

- Power and control cable to DIN VDE 0276 part 603, HD 603 S1 and IEC 60502
- **Temperature range**  
Flexing -5°C up to +50°C  
Fixed installation -40°C up to +70°C
- Permissible **operating temperature** at conductor +70°C
- Permissible **short circuit temperature** +160°C (short circuit duration 5 sec.)
- **Nominal voltage** U<sub>0</sub>/U 0.6/1 kV
- **Test voltage** 4 kV
- Max. permissible tensile stress with cable grip for Alu-conductor = 30 N/mm<sup>2</sup>
- **Minimum bending radius**  
For multi core approx. 12x cable Ø  
For single core approx. 15x cable Ø

## Cable structure

- Solid aluminium conductor, as per VDE 0295 cl. 1 or cl. 2 (round and sector shaped), BS 6360 cl. 1 or cl. 2, IEC 60228 and HD 383
- PVC core insulation, DIV4 to HD 603.1
- Conductor colours: green-yellow, brown, black, grey
- Cores stranded in layers
- Inner covering
- PVC outer jacket black, DMV5 to HD 603.1
- Sheath colour black

## Properties

- PVC self-extinguishing and flame retardant according to VDE 0482-332-1-2, DIN EN 60332-1-2/ IEC 60332-1 (equivalent DIN VDE 0472 part 804 test method B)
- The materials used in manufacture are cadmium-free and contain no silicone and free from substances harmful to the wetting properties of lacquers
- **Highest permissible voltage**
- Direct current systems 1.8 kV
- Alternating current systems, single-phase systems 1.4 kV; both conductors insulated, single-phase systems 0.7 kV; One conductor earthed, three-phase systems 1.2 kV; with concentric conductor and a cross-section of 240 mm<sup>2</sup> and above 3.6 kV

## Application

Power cables for energy supply are installed in open air, in underground, in water, indoors, in cable ducts, power stations, for industry and distribution boards as well as in subscriber networks, where mechanical damages are not be expected.

CE = The product is conformed with the EC Low-Voltage Directive 2006/95/EG.

## Note

- re = round solid core; se = sectional core;
- rm = stranded core; sm = sectional core;
- AWG sizes are approximate equivalent values. The actual cross-section is in mm<sup>2</sup>.

## Multi core

No. cores x cross-sec. mm <sup>2</sup>	Outer Ø app. mm	Alu weight kg / km	Weight app. kg / km	Part.-Nr. J-type	AWG-No.	Part.-Nr. O-type	AWG-No.
4 x 16 re	23,0	186,0	750,0	32301	6	32184	6
4 x 25 re	26,0	290,0	950,0	32302	4	32185	4
4 x 35 re	28,5	406,0	1120,0	32303	2	32186	2
4 x 50 se	30,0	580,0	1151,0	32304	1	32187	1
4 x 70 se	35,0	812,0	1549,0	32305	2/0	32188	2/0
4 x 95 se	39,5	1102,0	2030,0	32306	3/0	32189	3/0
4 x 95 sm	39,5	1102,0	2030,0	32177	3/0	32190	3/0
4 x 120 se	44,0	1392,0	2400,0	32307	4/0	32191	4/0
4 x 120 sm	44,0	1392,0	2400,0	32178	4/0	32192	4/0
4 x 150 se	46,0	1740,0	3030,0	32308	300 kcmil	32193	300 kcmil
4 x 150 sm	46,0	1740,0	3030,0	32179	300 kcmil	32194	300 kcmil
4 x 185 se	51,0	2146,0	3650,0	32309	350 kcmil	32195	350 kcmil
4 x 185 sm	51,0	2146,0	3650,0	32180	350 kcmil	32196	350 kcmil
4 x 240 se	56,0	2784,0	4800,0	32310	500 kcmil	32197	500 kcmil
4 x 240 sm	56,0	2784,0	4800,0	32181	500 kcmil	32198	500 kcmil
4 x 300 se	64,0	3480,0	5596,0	32182	600 kcmil	32199	600 kcmil
4 x 300 sm	64,0	3480,0	5596,0	32185	600 kcmil	32258	600 kcmil
5 x 10 re	22,0	145,0	637,0	33275	8	33283	8
5 x 16 re	25,0	232,0	832,0	33276	6	33284	6
5 x 25 re	28,0	363,0	1175,0	33277	4	33285	4
5 x 35 re	31,0	508,0	1399,0	33278	2	33286	2
5 x 50 sm	35,0	725,0	1855,0	33279	1	33287	1
5 x 70 sm	40,0	1015,0	2351,0	33280	2/0	33288	2/0
5 x 95 sm	45,0	1378,0	3071,0	33281	3/0	33289	3/0
5 x 120 sm	49,0	1740,0	3631,0	33282	4/0	33290	4/0

## Single core

No. cores x cross-sec. mm <sup>2</sup>	Outer Ø app. mm	Alu weight kg / km	Weight app. kg / km	Part.-Nr. J-type	AWG-No.	Part.-Nr. O-type	AWG-No.
1 x 35 re	13,0	102,0	240,0	32328	2	32311	2
1 x 50 rm	15,0	145,0	360,0	32329	1	32312	1
1 x 70 rm	16,5	203,0	410,0	32390	2/0	32313	2/0
1 x 95 rm	19,0	276,0	570,0	32391	3/0	32314	3/0
1 x 120 rm	20,5	348,0	691,0	32392	4/0	32315	4/0
1 x 150 rm	22,5	435,0	804,0	32393	300 kcmil	32321	300 kcmil
1 x 185 rm	25,0	537,0	979,0	32394	350 kcmil	32322	350 kcmil
1 x 240 rm	28,0	696,0	1253,0	32395	500 kcmil	32323	500 kcmil
1 x 300 rm	30,0	870,0	1395,0	32396	600 kcmil	32324	600 kcmil
1 x 400 rm	34,0	1160,0	1890,0	32397	750 kcmil	32325	750 kcmil
1 x 500 rm	38,0	1450,0	2600,0	32398	1000 kcmil	32326	1000 kcmil
1 x 630 rm	43,0	1827,0	2780,0	32399	-	32327	-

Dimensions and specifications may be changed without prior notice. (RQ01)





RoHS

### Technical Data

- Power and control cable to DIN VDE 0276 part 603, HD 603 S1 and IEC 60502  
7 cores and above to DIN VDE 0276 part 627, HD 627 S1 and IEC 60502
- **Temperature range**  
Flexing -5°C up to +50°C  
Fixed installation -40°C up to +70°C
- Permissible **operating temperature** at conductor +70°C
- Permissible **short circuit temperature** +160°C (short circuit duration 5 sec.)
- **Nominal voltage** U<sub>0</sub>/U 0.6/1 kV
- **Test voltage** 4 kV
- Max. permissible **tensile stress** with cable grip for Cu-conductor = 50 N/mm<sup>2</sup>
- **Minimum bending radius**  
For single core approx. 15x cable Ø  
For multi core approx. 12x cable Ø

### Cable structure

- Plain copper solid conductor as per VDE 0295 cl. 1, BS 6360 cl. 1, IEC 60228 and HD 383
- PVC core insulation, DIV4 to HD 603.1
- Colour coded to VDE 0293-308 and HD 186
- Cores stranded concentrically
- Filling compound
- Concentric conductor in inner layer of round copper wires, outer layer with copper tape
- PVC outer sheath, DMV5 to HD 603.1
- Sheath colour black

### Properties

- PVC self-extinguishing and flame retardant according to VDE 0482-332-1-2, DIN EN 60332-1-2/ IEC 60332-1 (equivalent DIN VDE 0472 part 804 test method B)
- The materials used in manufacture are cadmium-free and contain no silicone and free from substances harmful to the wetting properties of lacquers
- **Highest permissible voltage**
- Direct current systems 1.8 kV
- Alternating current systems, single-phase systems 1.4 kV  
Both conductors insulated, single-phase systems 0.7 kV  
One conductor earthed, three-phase systems 1.2 kV  
With concentric conductor and a cross-section of 240 mm<sup>2</sup> and above 3.6 kV

### Note

- re = round solid core.
- Available with outer sheath in alternative colours on request.

### Application

Power cables for energy supply are used for industry and distribution boards, power stations, house connecting boxes and street lighting as well as control cable for the transmission of control impulses and test datas.

Overall, where increased electrical and also mechanical protection are required.

Those cables are installed in open air, in underground, in water, indoors and in cable ducts.

The concentric conductor (C) is allowed to use as PE-, PEN-conductor or as screen

CE = The product is conformed with the EC Low-Voltage Directive 2006/95/EG.

Part No.	No. cores x cross-sec. mm <sup>2</sup>	Outer Ø app. mm	Cop. Weight kg / km	Weight app. kg / km	AWG-No.
32200	1 x 10 re / 10	11.0	216.0	280.0	8
32201	1 x 16 re / 16	12.0	336.0	440.0	6
32202	2 x 1.5 re / 1.5	13.0	52.0	205.0	16
32203	2 x 2.5 re / 2.5	13.5	80.0	270.0	14
32204	2 x 4 re / 4	15.5	123.0	360.0	12
32205	2 x 6 re / 6	17.0	182.0	435.0	10
32206	2 x 10 re / 10	19.5	312.0	590.0	8
32207	2 x 16 re / 16	20.5	489.0	820.0	6
32208	3 x 1.5 re / 1.5	13.5	66.0	225.0	16
32209	3 x 2.5 re / 2.5	14.5	104.0	290.0	14
32210	3 x 4 re / 4	16.5	161.0	400.0	12
32211	3 x 6 re / 6	17.5	240.0	510.0	10
32212	3 x 10 re / 10	20.0	408.0	850.0	8
32213	3 x 16 re / 16	23.0	643.0	1080.0	6
32214	4 x 1.5 re / 1.5	14.5	81.0	260.0	16
32215	4 x 2.5 re / 2.5	15.5	128.0	350.0	14
32216	4 x 4 re / 4	17.0	200.0	470.0	12
32217	4 x 6 re / 6	18.5	297.0	590.0	10
32218	4 x 10 re / 10	21.0	504.0	900.0	8
32219	4 x 16 re / 16	23.0	796.0	1250.0	6

Dimensions and specifications may be changed without prior notice. (RQ01)

Continuation »

Part No.	No. cores x cross-sec. mm <sup>2</sup>	Outer Ø app. mm	Cop. Weight kg / km	Weight app. kg / km	AWG-No.
32220	5 x 1.5 re / 1.5	15.0	95.0	330.0	16
32221	5 x 2.5 re / 2.5	16.0	152.0	400.0	14
32222	5 x 4 re / 4	19.0	238.0	560.0	12
32223	5 x 6 re / 6	21.0	355.0	710.0	10
32224	5 x 10 re / 10	23.0	600.0	1000.0	8
32227	7 x 1.5 re / 2.5	16.0	133.0	350.0	16
32241	7 x 2.5 re / 2.5	17.5	200.0	450.0	14
32225	7 x 4 re / 4	21.0	315.0	670.0	12
32255	7 x 6 re / 6	24.0	470.0	790.0	10
32229	8 x 1.5 re / 2.5	17.0	147.0	400.0	16
32242	8 x 2.5 re / 4	18.0	224.0	510.0	14
32230	10 x 1.5 re / 2.5	19.0	176.0	440.0	16
32243	10 x 2.5 re / 4	20.5	286.0	600.0	14
32231	12 x 1.5 re / 2.5	20.0	205.0	500.0	16
32244	12 x 2.5 re / 4	21.0	334.0	660.0	14
32232	14 x 1.5 re / 2.5	20.5	234.0	540.0	16
32245	14 x 2.5 re / 4	22.0	382.0	760.0	14
32246	14 x 2.5 re / 6	22.5	403.0	800.0	14
32233	16 x 1.5 re / 4	22.0	276.0	600.0	16
32247	16 x 2.5 re / 6	23.0	451.0	910.0	14
32234	19 x 1.5 re / 4	23.0	320.0	690.0	16
32248	19 x 2.5 re / 6	23.5	523.0	950.0	14
32235	21 x 1.5 re / 6	24.0	369.0	810.0	16
32249	21 x 2.5 re / 10	26.0	571.0	1100.0	14
32236	24 x 1.5 re / 6	26.0	413.0	860.0	16
32250	24 x 2.5 re / 10	28.0	696.0	1300.0	14
32237	30 x 1.5 re / 6	27.0	499.0	1230.0	16
32251	30 x 2.5 re / 10	30.0	840.0	1610.0	14
32238	40 x 1.5 re / 10	30.0	696.0	1590.0	16
32252	40 x 2.5 re / 10	35.0	1080.0	2100.0	14
32239	52 x 1.5 re / 10	32.0	869.0	1820.0	16
32253	52 x 2.5 re / 10	38.0	1368.0	2500.0	14
32240	61 x 1.5 re / 10	33.0	998.0	2000.0	16
32254	61 x 2.5 re / 10	40.0	1584.0	2850.0	14

Dimensions and specifications may be changed without prior notice. (RQ01)



## Direct burial cables and medium voltage cables directly from the Berlin warehouse

- Large warehouse (50,000 m<sup>2</sup>) with many different types, many cross sections, large quantities
- Delivery at short notice from the Berlin warehouse, also for cutting to length, follow-up deliveries
- Guaranteed VDE-certified, DIN VDE 0276
- On-time delivery on the construction site, on disposable drums if required



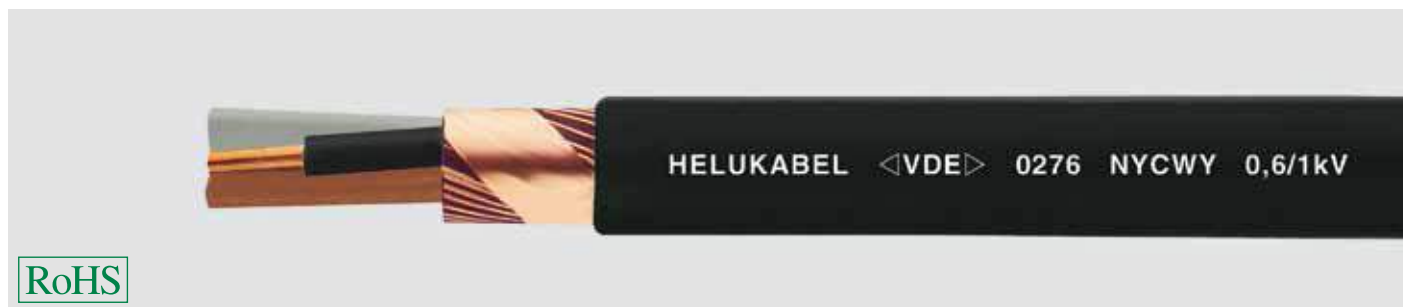

## Technical Data

- Power and control cable to DIN VDE 0276 part 603, HD 603 S1 and IEC 60502
- **Temperature range**  
Flexing -5°C up to +50°C  
Fixed installation -40°C up to +70°C
- **Permissible operating temperature**  
At conductor +70°C
- **Permissible short circuit temperature**  
+160°C (short circuit duration 5 sec.)
- **Nominal voltage**  $U_0/U$  0.6/1 kV
- **Test voltage** 4 kV
- Max. permissible tensile stress with cable grip for Cu-conductor = 50 N/mm<sup>2</sup>
- **Minimum bending radius**  
For single core approx. 15x cable Ø  
For multi core approx. 12x cable Ø

## Cable structure

- Plain copper conductors, as per VDE 0295 cl. 1 od. cl. 2, IEC 60228, BS 6360 cl. 1 and HD 383, solid or stranded versions, conductor types  
10-16 mm<sup>2</sup> round, solid cores (re) alt.  
10-25 mm<sup>2</sup>, stranded conductor (rm),  
35-240 mm<sup>2</sup>, sector shaped conductor, stranded (sm)
- PVC core insulation, DIV4 to HD 603.1
- Colour coded to DIN VDE 0293-308 and HD 186
- Cores stranded concentrically
- Filling compound  
Concentric conductor (Ceander), inner layer of corrugated copper wires, outer layer with copper tape
- PVC outer sheath, DMV5 to HD 603.1
- Sheath colour black

## Properties

- PVC self-extinguishing and flame retardant according to VDE 0482-332-1-2, DIN EN 60332-1-2/ IEC 60332-1 (equivalent DIN VDE 0472 part 804 test method B)
- The materials used in manufacture are cadmium-free and contain no silicone and free from substances harmful to the wetting properties of lacquers
- **Highest permissible voltage**
- Direct current systems 1.8 kV
- Alternating current systems, single-phase systems 1.4 kV  
Both conductors insulated, single-phase systems 0.7 kV
- One conductor earthed, three-phase systems 1.2 kV  
With concentric conductor and a cross-section of 240 mm<sup>2</sup> and above 3.6 kV

## Note

- At 25 mm<sup>2</sup> = round cables are more compact thus smaller core Ø.
- Available with outer sheath in alternative colours on request.
- re = round solid core;  
rm = stranded core;  
sm = sectional core.

## Application

Power cables for energy supply, preferably used for underground laying, especially in subscriber networks, power stations as well as control cables for the transmission of control impulses and test datas. Overall, where increased electrical and also mechanical protection are required. Those cables are installed in open air, in underground, in water, indoors and in cable ducts. The concentric conductor (C) is allowed to use as PE-, PEN-conductor or as screen. Due to the typical construction of corrugated concentric conductors (Ceander), are possible to obtain many more cable joints, without cutting any conductor. In that way the operating reliability is guaranteed.

CE = The product is conformed with the EC Low-Voltage Directive 2006/95/EG.

Part No.	No. cores x cross-sec. mm <sup>2</sup>	Outer Ø app. mm	Cop. Weight kg / km	Weight app. kg / km	AWG-No.
32260	2 x 10 re/10	19.0	312.0	650.0	8
32261	2 x 16 re/16	21.0	489.0	850.0	6
32262	2 x 25 rm/25	24.0	763.0	1210.0	4
32263	3 x 10 re/10	19.5	408.0	730.0	8
32264	3 x 16 re/16	22.0	643.0	1000.0	6
32265	3 x 25 rm/16	26.0	902.0	1550.0	4
32274	3 x 25 rm/25	26.0	1003.0	1600.0	4
32275	3 x 35 sm/35	27.5	1402.0	1850.0	2
32266	3 x 35 sm/16	27.0	1190.0	1750.0	2
32276	3 x 50 sm/50	29.5	2000.0	2450.0	1
32267	3 x 50 sm/25	29.0	1723.0	2250.0	1
32277	3 x 70 sm/70	34.0	2796.0	3350.0	2/0
32268	3 x 70 sm/35	33.0	2410.0	2950.0	2/0
32278	3 x 95 sm/95	38.5	3791.0	4550.0	3/0
32269	3 x 95 sm/50	38.0	3296.0	4100.0	3/0
32270	3 x 120 sm/70	41.0	4236.0	5050.0	4/0
32279	3 x 120 sm/120	42.0	4786.0	5550.0	4/0
32271	3 x 150 sm/70	45.0	5100.0	6000.0	300 kcmil
32280	3 x 150 sm/150	46.0	5970.0	6900.0	300 kcmil
32272	3 x 185 sm/95	50.0	6383.0	7550.0	350 kcmil
32281	3 x 185 sm/185	51.0	7363.0	8500.0	350 kcmil
32273	3 x 240 sm/120	57.0	8242.0	9950.0	500 kcmil

Dimensions and specifications may be changed without prior notice. (RQ01)

Continuation »

Part No.	No. cores x cross-sec. mm <sup>2</sup>	Outer Ø app. mm	Cop. Weight kg / km	Weight app. kg / km	AWG-No.
32282	4 x 10 re/10	20.5	504.0	890.0	8
32283	4 x 16 re/16	23.5	796.0	1250.0	6
32284	4 x 25 rm/16	28.0	1142.0	1800.0	4
32285	4 x 35 sm/16	29.0	1526.0	2050.0	2
32286	4 x 50 sm/25	33.0	2203.0	2700.0	1
32287	4 x 70 sm/35	37.0	3082.0	3750.0	2/0
32288	4 x 95 sm/50	43.5	4208.0	5000.0	3/0
32289	4 x 120 sm/70	47.0	5388.0	6350.0	4/0
32290	4 x 150 sm/70	51.0	6540.0	7650.0	300 kcmil
32291	4 x 185 sm/95	56.0	8159.0	9350.0	350 kcmil
32292	4 x 240 sm/120	62.5	10546.0	11600.0	500 kcmil

Dimensions and specifications may be changed without prior notice. (RQ01)

## CABLES AND WIRES

**The extensive standard range of cables and wires for many applications and nearly every purpose – available directly ex warehouse.**

HELUKABEL® supplies cables and wires for all industry sectors, applications and every purpose. Our comprehensive stock assortment with over 33,000 products lets us cover your needs with short delivery times.

Our large standard range includes the following products:

flexible control cables · data and computer cables · cables for drag chains  
 cables according to international standards · servo-, feedback- and motor cables  
 heat resistant wires · allweather and rubber cables · trailing cables · robot cables  
 water resistant cables · flat and ribbon cables · single conductors · spiral cables  
 compensating cables · installation cables · telephone and fire wiring cables  
 coaxial cables · power cables, security cables and medium voltage cables  
 special cables · shipwiring and marine cables and much more.

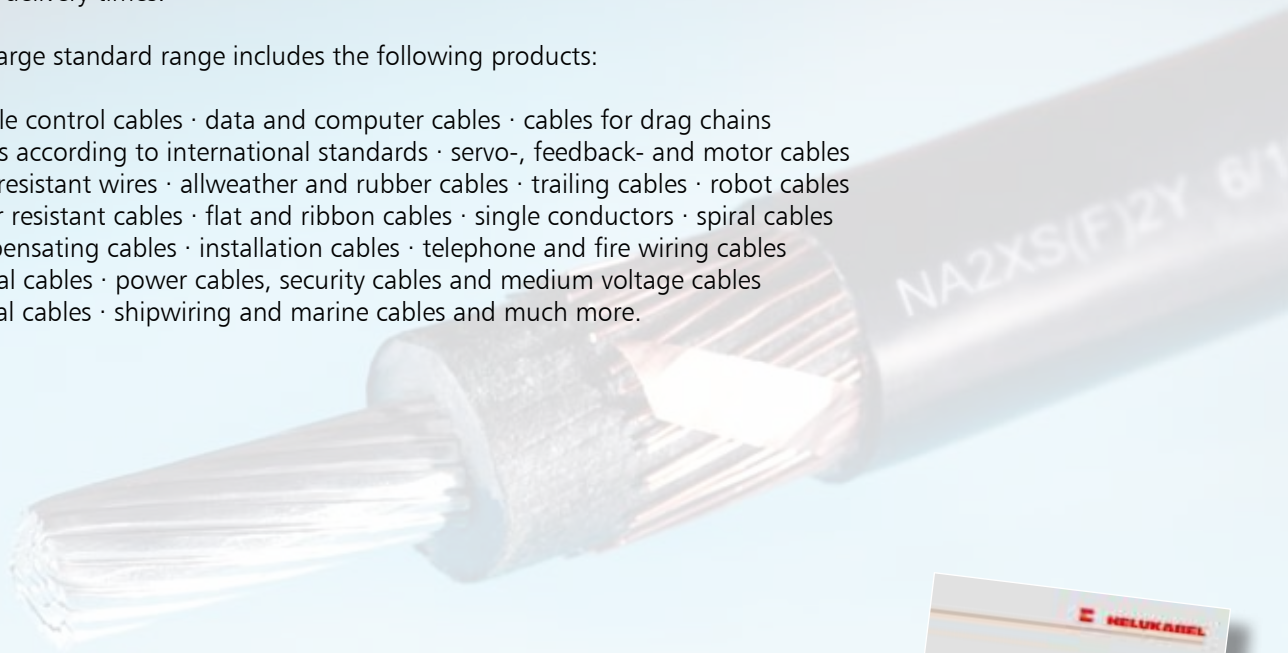

Ask for more information, available in our current Cables & Wires catalogue via Internet or Fax (for Fax enquiry see page 71).



## Technical Data

- Power and control cable according to DIN VDE 0276 Part 603 or HD 603 S1 and IEC 60502
- **Temperature range**  
Flexing -5°C up to +50°C  
Fixed installation -40°C up to +70°C
- **Permissible operating temperature**  
At conductor +70°C
- **Permissible short circuit temperature**  
+160°C (short circuit duration 5 sec.)
- **Nominal voltage**  $U_0/U$  0.6/1 kV
- **Test voltage** 4 kV
- Max. permissible tensile load with cable grip = 30 N/mm<sup>2</sup>
- **Minimum bending radius**  
Approx. 12x cable Ø

## Cable structure

- Aluminium conductor according to DIN VDE 0295 cl. 1, IEC 60228, BS 6360 cl. 1 or HD 383  
16 to 25 mm<sup>2</sup>, round conductor  
Single-wire (re) or 35-240 mm<sup>2</sup>, sector-shaped conductor, multi-wire (sm)
- PVC core insulation, DIV4 in accordance with HD 603.1 Core colour according to DIN VDE 0293-308 or HD 186
- Core colour according to DIN VDE 0293-308 and HD 186
- Cores stranded in concentric layers
- Filling compound
- Concentric conductor, inner layer Corrugated (Ceander), round, Bare copper wires, outer layer Copper tape as counter helix
- PVC outer sheath, DMV5 to HD 603.1
- Sheath colour black

## Properties

- PVC self-extinguishing and flame retardant in accordance with VDE 0482-332-1-2, DIN EN 60332-1-2/ IEC 60332-1 (conforms to DIN VDE 0472 Part 804 Test method B)
- The materials used in manufacture are free of silicone, cadmium and substances that impair paint wetting
- **Highest permissible voltage**
- Direct current systems 1.8 kV
- Three-phase systems  
Single-phase systems:  
Both outer conductors insulated 1.4 kV  
Single-phase systems:  
One outer conductor earthed 0.7 kV
- Three-phase system 1.2 kV with concentric conductor and a cross-section from 240 mm<sup>2</sup> 3.6 kV

## Note

- re = round conductor, single-wire;  
sm = sector-shaped conductor, multi-wire.

## Application

Power distribution cables, preferably used for underground installation, primarily in local networks, for industrial applications and switching systems, power stations. Wherever increased electrical and mechanical protection are required. Installation in water, outdoors, in concrete, indoors and in cable ducts. The concentric conductor (C) can be used as a PE or PEN conductor or as a screen. The corrugated design (Ceander) of the concentric conductor permits any number of cable junctions during assembly, without any conductors having to be cut. This guarantees optimised reliability.

CE = The product conforms to the EG Low-Voltage Directive 2006/95/EG.

Part No.	Number of cores x nominal cross section mm <sup>2</sup>	Outer Ø mm	Cop. Weight kg/km	Alu weight approx. kg/km	Weight approx. kg/km
32840	4x16 re/16	21,5	182	186	1250
32841	4x25 re/16	25,5	182	290	1800
32842	4x35 sm/16	27,1	182	406	2050
32843	4x50 sm/25	28,2	283	580	2700
32844	4x70 sm/35	32,3	394	814	3750
32845	4x95 sm/50	35,8	560	1102	5000
32846	4x120 sm/70	39,2	780	1392	6350
32847	4x150 sm/70	43,2	780	1740	7650
32848	4x185 sm/95	48,4	1056	2146	9350
32849	4x240 sm/120	56,0	1330	2784	11600

Dimensions and specifications may be changed without prior notice.



## Technical Data

- Power and control cable according to DIN VDE 0276 part 604, HD 604 S1 part 1 and part 5G
- **Conductor resistance** (at 20°C) according to VDE 0295 cl. 1 or 2 and IEC 60228 cl. 1 or 2 and HD 383 cl. 1 and cl. 2
- **Temperature range** during installation -5°C up to +50°C fixed installation -30°C up to +90°C
- **Permissible operating temperature** at conductor 90°C
- **Nominal voltage**  $U_0/U$  0,6/1 kV
- **Test voltage** 4 kV
- **Minimum bending radius** single-core approx. 15x cable Ø multi-core approx. 12x cable Ø
- **Radiation resistance** up to  $100 \times 10^5$  cJ/kg (up to 100Mrad)

## Cable structure

- Plain Cu wire conductor, single or multiple-wire, according to DIN VDE 0295 cl. 1 or 2, BS 6360 cl. 1 or 2 and IEC 60228 cl. 1 or 2, HD 383
- Halogen-free core insulation, cross-linked polyethylene compound 2X11, to HD 604 S1
- Colour coding of cores according to DIN VDE 0293-308 and HD 186
- Green-yellow earth-core, 3 cores and above
- Cores stranded in layers (for multi-core cables)
- Overall filled inner sheath, covered by filling compound or wrapped tape
- Outer sheath of thermoplastic polyolefine compound HM4, to HD 604 S1
- Sheath colour black
- LSOH = Low Smoke Zero Halogen-free

## Properties

- Halogen-free, no separation of corrosive or toxic gases
- Limited propagation of fire
- Low smoke development
- The materials used in manufacture are cadmium-free and contain no silicone and free from substances harmful to the wetting properties of lacquers

### Tests

- Flame test to VDE 0482-332-3, BS 4066 part 3/ DIN EN 60332-3/ IEC 60332-3 (equivalent DIN VDE 0472 part 804 test method C)
- Corrosiveness of combustion gases according to VDE 0482 part 267/ DIN EN 50267-2-2/ IEC 60754-2 (equivalent DIN VDE 0472 part 813)
- Halogen-free according to DIN VDE 0482 part 267/ DIN EN 50267-2-1/ IEC 60754-1 (equivalent DIN VDE 0472 part 815)
- Halogen-free according to DIN VDE 0482 part 267/ DIN EN 50267-2-1/ IEC 60754-1 (equivalent DIN VDE 0472 part 815)

## Note

- rm = round conductor, multiple-wire;  
re = round conductor, single-wire

## Application

Halogen-free power cables with enhanced characteristics in case of fire are used for applications where harm to human life and damage to property must be prevented in the event of fire, e.g. in industrial installations, communal establishments, hotels, airports, underground stations, railway stations, hospitals department stores, banks, schools theaters, multi-storey buildings, process control centres etc. Suitable for fixed installation in dry, damp or wet environments, in, above, on and beneath plaster as well as in masonry walls and in concrete. These cables are suitable for outdoor applications and in underground by using in conduits or tubes.

CE = The product is conformed with the EC Low-Voltage Directive 2006/95/EG.

Part No. J-type	Part No. O-type	No. cores x cross-sec. mm <sup>2</sup>	Outer Ø app. mm	Cop. weight kg/km	Weight app. kg/km	AWG No.	Part No. J-type	Part No. O-type	No. cores x cross-sec. mm <sup>2</sup>	Outer Ø app. mm	Cop. weight kg/km	Weight app. kg/km	AWG No.
53100	53248	1 x 4 re	8,0	39,0	68,0	12	53121	53269	3 x 1,5 re	13,0	43,0	220,0	16
53101	53249	1 x 6 re	9,0	58,0	90,0	10	53122	53270	3 x 2,5 re	14,0	72,0	280,0	14
53102	53250	1 x 10 re	9,0	96,0	140,0	8	53123	53271	3 x 4 re	15,0	115,0	350,0	12
53103	53251	1 x 16 re	10,0	154,0	190,0	6	53124	53272	3 x 6 re	16,0	173,0	420,0	10
53104	53252	1 x 25 rm	11,0	240,0	290,0	4	53125	53273	3 x 10 re	18,0	288,0	600,0	8
53105	53253	1 x 35 rm	12,0	336,0	390,0	2	53126	53274	3 x 16 re	20,0	461,0	770,0	6
53106	53254	1 x 50 rm	15,0	480,0	510,0	1	53127	53275	3 x 25 rm	21,8	720,0	1120,0	4
53107	53255	1 x 70 rm	17,0	672,0	710,0	2/0	53128	53276	3 x 35 rm	24,9	1008,0	1550,0	2
53108	53256	1 x 95 rm	19,0	912,0	960,0	3/0	53129	53277	3 x 50 rm	25,2	1440,0	1750,0	1
53109	53257	1 x 120 rm	21,0	1152,0	1200,0	4/0	53130	53278	3 x 70 rm	29,2	2016,0	2450,0	2/0
53110	53258	1 x 150 rm	23,0	1440,0	1480,0	300 kcmil	53131	53279	3 x 95 rm	32,0	2736,0	3250,0	3/0
53111	53259	1 x 185 rm	25,0	1776,0	1910,0	350 kcmil	53132	53280	3 x 120rm	34,9	3456,0	4000,0	4/0
53112	53260	1 x 240 rm	28,0	2304,0	2370,0	500 kcmil	53133	53281	3 x 150rm	39,2	4320,0	5000,0	300 kcmil
53113	53261	1 x 300 rm	30,0	2880,0	2970,0	600 kcmil	53134	53282	3 x 185rm	44,1	5328,0	6150,0	350 kcmil
							53135	53283	3 x 240rm	49,2	6912,0	8000,0	500 kcmil
53114	53262	2 x 1,5 re	12,0	29,0	185,0	16	53143	53284	4 x 1,5 re	13,0	58,0	235,0	16
53115	53263	2 x 2,5 re	12,2	48,0	220,0	14	53144	53285	4 x 2,5 re	14,0	96,0	290,0	14
53116	53264	2 x 4 re	13,2	77,0	275,0	12	53145	53286	4 x 4 re	15,0	154,0	370,0	12
53117	53265	2 x 6 re	14,1	115,0	335,0	10	53146	53287	4 x 6 re	16,0	230,0	470,0	10
53118	53266	2 x 10 re	16,2	192,0	450,0	8	53147	53288	4 x 10 re	18,0	384,0	670,0	8
53119	53267	2 x 16 re	17,8	307,0	620,0	6	53148	53289	4 x 16 re	20,0	614,0	930,0	6
53120	53268	2 x 25 rm	21,0	480,0	930,0	4							

Dimensions and specifications may be changed without prior notice.

Continuation >

Part No. J-type	Part No. O-type	No. cores x cross-sec. mm	Outer Ø app. mm	Cop. weight kg/km	Weight app. kg/km	AWG No.
53149	53290	4 x 25	rm 25,0	960,0	1440,0	4
53150	53291	4 x 35	rm 27,0	1344,0	1890,0	2
53151	53292	4 x 50	rm 28,0	1920,0	2300,0	1
53152	53293	4 x 70	rm 32,0	2668,0	3200,0	2/0
53153	53294	4 x 95	rm 36,0	3648,0	4250,0	3/0
53154	53295	4 x 120	rm 40,2	4608,0	5350,0	4/0
53155	53296	4 x 150	rm 45,8	5760,0	6550,0	300 kcmil
53156	53297	4 x 185	rm 49,5	7104,0	8100,0	350 kcmil
53157	53298	4 x 240	rm 56,0	9216,0	10550,0	500 kcmil
53158	53299	5 x 1,5	re 14,5	72,0	280,0	16
53159	53309	5 x 2,5	re 16,0	120,0	350,0	14
53160	53310	5 x 4	re 17,0	192,0	450,0	12
53161	53311	5 x 6	re 18,5	288,0	600,0	10
53162	53312	5 x 10	re 21,0	480,0	850,0	8
53163	53313	5 x 16	re 24,0	768,0	1200,0	6
53164	53314	7 x 1,5	re 15,5	101,0	350,0	16
53171	53315	7 x 2,5	re 17,0	168,0	370,0	14
53178	53316	7 x 4	re 17,2	269,0	530,0	12
53165	53317	10 x 1,5	re 18,5	144,0	480,0	16
53172	53318	10 x 2,5	re 20,0	240,0	500,0	14
53166	53319	12 x 1,5	re 19,0	173,0	520,0	16
53173	53320	12 x 2,5	re 21,0	288,0	560,0	14
53179	53321	12 x 4	re 21,2	461,0	800,0	12
53167	53322	14 x 1,5	re 20,0	202,0	550,0	16
53174	53323	14 x 2,5	re 22,0	336,0	630,0	14
53168	53324	19 x 1,5	re 22,0	274,0	700,0	16
53175	53325	19 x 2,5	re 24,0	456,0	800,0	14
53169	53326	24 x 1,5	re 25,0	346,0	850,0	16
53176	53327	24 x 2,5	re 27,0	576,0	990,0	14
53170	53328	30 x 1,5	re 26,0	432,0	950,0	16
53177	53329	30 x 2,5	re 28,0	720,0	1180,0	14

Dimensions and specifications may be changed without prior notice.

Part No. J-type	Part No. O-type	No. cores x cross-sec. mm	Outer Ø app. mm	Cop. weight kg/km	Weight app. kg/km	AWG No.
53136	53330	3 x 50/25	rm 28,5	1680,0	2100,0	1
53137	53331	3 x 70/35	rm 31,4	2352,0	2800,0	2/0
53138	53332	3 x 95/50	rm 34,9	3216,0	3750,0	3/0
53139	53333	3 x 120/70	rm 38,0	4128,0	4750,0	4/0
53140	53334	3 x 150/70	rm 43,3	4992,0	5750,0	300 kcmil
53141	53335	3 x 185/95	rm 47,2	6240,0	7200,0	350 kcmil
53142	53336	3 x 240/120	rm 53,4	8064,0	9300,0	500 kcmil



## Technical Data

- Power and control cable according to DIN VDE 0276 part 604, HD 604 S1 part 1 and part 5G
- **Conductor resistance** (at 20°C) according to VDE 0295 cl. 1 or 2 and IEC 60228 cl. 1 or 2 and HD 383 cl. 1 and cl. 2
- **Temperature range** during installation -5°C up to +50°C fixed installation -30°C up to +90°C
- Permissible **operating temperature** at conductor +90°C
- **Nominal voltage**  $U_0/U$  0,6/1 kV
- **Test voltage** 4 kV
- **Minimum bending radius** approx. 12x cable  $\emptyset$
- **Radiation resistance** up to  $100 \times 10^6$  cJ/kg (up to 100Mrad)

## Cable structure

- Plain Cu wire conductor, single or multiple-wire, according to DIN VDE 0295 cl. 1 or 2, BS 6360 cl. 1 or 2 and IEC 60228 cl. 1 or 2, HD 383
- Halogen-free core insulation, cross-linked polyethylene compound 2X11, to HD 604 S1
- Colour coding of cores according to DIN VDE 0293-308 and HD 186
- Cores stranded in layers (for multi-core cables)
- Overall filled inner sheath, covered by filling compound or wrapped tape
- Concentric conductor of plain Cu wires
- Outer sheath of thermoplastic polyolefine compound HM4, to HD 604 S1
- Sheath colour black
- **LSOH** = Low Smoke Zero Halogen-free
- The materials used in manufacture are cadmium-free and contain no silicone and free from substances harmful to the wetting properties of lacquers

## Properties

- Halogen-free, no separation of corrosive or toxic gases
- Limited propagation of fire
- Low smoke development

### Tests

- Smoke density according to VDE 0482 part 1034-1+2 / IEC 61034-1+2 / DIN EN 61034-1+2 / BS 7622 part 1+2 (equivalent DIN VDE 0472 part 816)
- Flame test to VDE 0482-332-3, BS 4066 part 3/ DIN EN 60332-3/ IEC 60332-3 (equivalent DIN VDE 0472 part 804 test method C)
- Corrosiveness of combustion gases according to VDE 0482 part 267/ DIN EN 50267-2-2/ IEC 60754-2 (equivalent DIN VDE 0472 part 813)
- Halogen-free according to VDE 0482 part 267/ DIN EN 50267-2-1/ IEC 60754-1 (equivalent DIN VDE 0472 part 815)

## Note

- rm = round conductor, multiple-wire; re = round conductor, single-wire

## Application

The concentric conductor can be used as PE- PEN conductor or as screen. Suitable for fixed installation in dry, damp or wet environments, in, above, on and beneath plaster as well as in masonry walls and in concrete. These cables are suitable for outdoor applications and in underground by using in conduits or tubes.

CE = The product is conformed with the EC Low-Voltage Directive 2006/95/EG.

Part No.	No. cores x cross-sec. mm <sup>2</sup>	Outer Ø app. mm	Cop. Weight kg / km	Weight app. kg / km	AWG-No.	Part No.	No. cores x cross-sec. mm <sup>2</sup>	Outer Ø app. mm	Cop. Weight kg / km	Weight app. kg / km	AWG-No.
53200	2 x 1,5 / 1,5 re	14,0	53,0	250,0	16	53229	4 x 50 / 25 rm	32,5	2203,0	2800,0	1
53201	2 x 2,5 / 2,5 re	15,0	81,0	280,0	14	53230	4 x 70 / 35 rm	38,0	3082,0	3800,0	2/0
53202	2 x 4 / 4 re	14,0	122,0	320,0	12	53231	4 x 95 / 50 rm	43,5	4208,0	5100,0	3/0
53203	2 x 6 / 6 re	15,0	183,0	400,0	10	53758	4 x 120 / 70 rm	50,5	5382,0	6556,0	4/0
53204	2 x 10 / 10 re	16,0	311,0	560,0	8	53759	4 x 150 / 70 rm	52,1	6540,0	7600,0	300 kcmil
53205	2 x 16 / 16 re	19,1	490,0	780,0	6	53760	4 x 185 / 95 rm	57,2	8159,0	9370,0	350 kcmil
53206	3 x 1,5 / 1,5 re	14,5	67,0	250,0	16	53761	4 x 240 / 120 rm	62,6	10546,0	11611,0	500 kcmil
53207	3 x 2,5 / 2,5 re	15,5	104,0	320,0	14	53232	7 x 1,5 / 2,5 re	14,5	132,0	320,0	16
53208	3 x 4 / 4 re	16,5	161,0	400,0	12	53239	7 x 2,5 / 2,5 re	15,1	200,0	400,0	14
53209	3 x 6 / 6 re	18,0	242,0	500,0	10	53246	7 x 4 / 4 re	18,1	316,0	580,0	12
53210	3 x 10 / 10 re	20,0	408,0	750,0	8	53233	10 x 1,5 / 2,5 re	17,2	177,0	420,0	16
53211	3 x 16 / 16 re	22,5	643,0	1000,0	6	53240	10 x 2,5 / 4 re	18,9	287,0	550,0	14
53212	3 x 25 / 16 rm	27,0	1001,0	1600,0	4	53234	12 x 1,5 / 2,5 re	18,4	204,0	460,0	16
53213	3 x 35 / 16 rm	27,5	1190,0	1900,0	2	53241	12 x 2,5 / 4 re	19,2	335,0	610,0	14
53214	3 x 50 / 25 rm	32,3	2003,0	2400,0	1	53247	12 x 4 / 6 re	22,6	528,0	910,0	12
53215	3 x 70 / 35 rm	35,6	2794,0	3060,0	2/0	53235	16 x 1,5 / 4 re	20,0	275,0	686,0	16
53216	3 x 95 / 50 rm	39,0	3790,0	4200,0	3/0	53242	16 x 2,5 / 6 re	20,9	450,0	805,0	14
53217	3 x 120 / 70 rm	42,0	4785,0	5207,0	4/0	53236	21 x 1,5 / 6 re	22,6	370,0	766,0	16
53218	3 x 150 / 70 rm	43,5	5100,0	5700,0	300 kcmil	53243	21 x 2,5 / 6 re	25,2	572,0	1015,0	14
53219	3 x 185 / 95 rm	47,4	6381,0	7150,0	350 kcmil	53237	24 x 1,5 / 6 re	23,2	412,0	800,0	16
53220	3 x 240 / 120 rm	53,5	8240,0	9250,0	500 kcmil	53244	24 x 2,5 / 10 re	26,1	695,0	1100,0	14
53221	4 x 1,5 / 1,5 re	15,5	81,0	300,0	16	53238	30 x 1,5 / 6 re	24,3	500,0	930,0	16
53222	4 x 2,5 / 2,5 re	16,5	129,0	380,0	14	53245	30 x 2,5 / 10 re	28,0	842,0	1290,0	14
53223	4 x 4 / 4 re	17,5	202,0	480,0	12						
53224	4 x 6 / 6 re	19,0	297,0	600,0	10						
53225	4 x 10 / 10 re	21,5	504,0	850,0	8						
53226	4 x 16 / 16 re	24,5	797,0	1200,0	6						
53227	4 x 25 / 16 rm	29,0	1142,0	1800,0	4						
53228	4 x 35 / 16 rm	29,5	1528,0	2100,0	2						

Dimensions and specifications may be changed without prior notice. (R001)





RoHS

## Technical Data

- PVC-sheathed cable to DIN VDE 0250 part 204
- **Temperature range**  
Flexing +5°C up to +70°C  
Fixed installation -40°C up to +70°C
- **Nominal voltage**  
U<sub>0</sub>/U 300/500 V
- **Test voltage** 2000 V
- **Minimum bending radius**  
Fixed installation 4x cable Ø
- **Radiation resistance**  
Up to 80x10<sup>6</sup> cJ/kg (up to 80 Mrad)

## Cable structure

- Solid or stranded, plain copper conductor to DIN VDE 0295 cl. 1 or cl. 2, BS 6360 cl. 1 or cl. 2 and IEC 60228 cl. 1 or cl. 2
- PVC core insulation, T11 to DIN VDE 0281 part 1
- Colour coded to DIN VDE 0293-308
- Cores stranded in layer
- Special PVC outer sheath TM1, to DIN VDE 0281 part 1
- Jacket colour grey (RAL 7035)

## Properties

- PVC self-extinguishing and flame retardant according to VDE 0482-332-1-2, DIN EN 60332-1-2/ IEC 60332-1 (equivalent DIN VDE 0472 part 804 test method B)

## Note

- re = round conductor, single-wire;  
rm = round conductor, multiple-wire.
- G = with green-yellow earth core;  
x = without green-yellow earth core (OZ).
- AWG sizes are approximate equivalent values.  
The actual cross-section is in mm<sup>2</sup>.

## Application

For industrial- and wiring purposes.

Usable in the open, in dry, damp and wet environments in the open and concealed, as well as in masonry and in beton, not suitable for imbedding in solidified- or compressed-concrete. Outdoor usage is only possible, as long as the cable is protected against direct sunlight.

CE = The product is conformed with the EC Low-Voltage Directive 2006/95/EG.

Part No.	No. cores x cross-sec. mm <sup>2</sup>		Outer Ø app. mm	Cop. Weight kg / km	Weight app. kg / km	AWG-No.	Part No.	No. cores x cross-sec. mm <sup>2</sup>		Outer Ø app. mm	Cop. Weight kg / km	Weight app. kg / km	AWG-No.
39050	1 G 1.5	re	5.4	14.4	40.0	16	39052	1 G 6	re	7.2	58.0	105.0	10
39001	1 x 1.5	re	5.4	14.4	40.0	16	39003	1 x 6	re	7.2	58.0	105.0	10
39006	2 x 1.5	re	8.7	29.0	170.0	16	39078	3 G 6	re	13.0	173.0	320.0	10
39056	3 G 1.5	re	9.1	43.0	135.0	16	39061	4 G 6	re	15.1	230.0	460.0	10
39007	3 x 1.5	re	9.1	43.0	135.0	16	39012	4 x 6	re	15.1	230.0	460.0	10
39058	4 G 1.5	re	9.8	58.0	160.0	16	39069	5 G 6	re	16.1	288.0	540.0	10
39009	4 x 1.5	re	9.8	58.0	160.0	16	39020	5 x 6	re	16.1	288.0	540.0	10
39066	5 G 1.5	re	10.3	72.0	190.0	16							
39017	5 x 1.5	re	10.3	72.0	190.0	16	39053	1 G 10	re	8.4	96.0	155.0	8
39072	7 G 1.5	re	11.5	101.0	235.0	16	39004	1 x 10	re	8.4	96.0	155.0	8
39023	7 x 1.5	re	11.5	101.0	235.0	16	39062	4 G 10	re	17.6	384.0	680.0	8
39076	10 G 1.5	re	13.8	144.0	330.0	16	39013	4 x 10	re	17.6	384.0	680.0	8
39077	12 G 1.5	re	14.4	173.0	405.0	16	39070	5 G 10	re	19.2	480.0	850.0	8
							39021	5 x 10	re	19.2	480.0	850.0	8
39055	1 G 2.5	re	6.0	24.0	70.0	14							
39024	1 x 2.5	re	6.0	24.0	70.0	14	39054	1 G 16	rm	9.9	154.0	230.0	6
39057	3 G 2.5	re	10.4	72.0	190.0	14	39005	1 x 16	rm	9.9	154.0	230.0	6
39008	3 x 2.5	re	10.4	72.0	190.0	14	39063	4 G 16	rm	21.3	614.0	1048.0	6
39059	4 G 2.5	re	11.3	96.0	230.0	14	39014	4 x 16	rm	21.3	614.0	1048.0	6
39010	4 x 2.5	re	11.3	96.0	230.0	14	39071	5 G 16	rm	23.4	768.0	1280.0	6
39067	5 G 2.5	re	12.0	120.0	270.0	14	39022	5 x 16	rm	23.4	768.0	1280.0	6
39018	5 x 2.5	re	12.0	120.0	270.0	14							
39075	7 G 2.5	re	13.2	168.0	342.0	14							
							39079	1 G 25	rm	12.0	240.0	325.0	4
39051	1 G 4	re	6.6	38.0	80.0	12	39064	4 G 25	rm	25.8	960.0	1649.0	4
39002	1 x 4	re	6.6	38.0	80.0	12	39015	4 x 25	rm	25.8	960.0	1649.0	4
39074	3 G 4	re	12.0	115.0	258.0	12	39073	5 G 25	rm	28.7	1200.0	1970.0	4
39060	4 G 4	re	13.0	154.0	330.0	12							
39011	4 x 4	re	13.0	154.0	330.0	12	39065	4 G 35	rm	28.5	1344.0	2000.0	2
39068	5 G 4	re	14.5	192.0	410.0	12	39016	4 x 35	rm	28.5	1344.0	2000.0	2
39019	5 x 4	re	14.5	192.0	410.0	12							

Dimensions and specifications may be changed without prior notice. (R001)

# N2XS<sub>Y</sub> 6/10kV, 12/20kV, 18/30kV

Medium voltage cable, XLPE-insulated, Cu-conductor, single core, screened, PVC-jacket



## Technical Data

- XLPE-insulated power cables to DIN VDE 0276 part 620, HD 620 S1 and IEC 60502
- **Temperature range**  
During installation up to -5°C
- **Operating temperature**  
Max. 90°C
- **Short circuit temperature**  
250°C (short circuit duration up to 5 sec.)
- **Nominal voltages**  
U<sub>0</sub>/U 6/10 kV, 12/20 kV, 18/30 kV
- **Operating voltages for**  
6/10 kV = max. 12 kV  
12/20 kV = max. 24 kV  
18/30 kV = max. 36 kV
- **Test voltages for**  
6/10 kV = 15 kV  
12/20 kV = 30 kV  
18/30 kV = 45 kV
- **Minimum bending radius**  
During installation max. 15x cable Ø

## Cable structure

- Circular bare Cu-conductor of stranded wires to HD 383
- Inner semi-conducting coating
- Core insulation of cross-linked Polyethylene (XLPE), PE-compound DIX8 to HD 620.1
- Outer extrusion of semi-conducting coating spliced with the insulation
- Wrapping of conductive material
- Screen: Braiding of copper wires with one or two tape(s) applied helically
- Wrapping
- PVC outer jacket, compound DMV6 to HD 620.1
- Jacket colour red

## Properties

- PVC self-extinguishing and flame retardant according to VDE 0482-332-1-2, DIN EN 60332-1-2/ IEC 60332-1 (equivalent DIN VDE 0472 part 804 test method B)
- The materials used in manufacture are cadmium-free and contain no silicone and free from substances harmful to the wetting properties of lacquers
- **Installation notes**  
To guarantee an optimum on operating reliability the extruded semi-conductive layer is spliced with the insulation for long duration. For this reason we recommend a peeling tool for installation.

## Note

- Further dimensions available on request

## Application

Suitable for installation mostly for power supply stations, in indoors and in cable ducts, outdoors, underground and in water as well as for installation on cable trays for industries, switch-boards and power stations. Due to the good laying characteristic, this can also be laid easily in difficult line guideways. The inner conducting layer between the conductor and the XLPE insulation and the firmly bonded outer conducting layer on the XLPE insulation assures a construction free of partial discharges with high operational reliability.

Part No.	No. cores x cross-sec. mm <sup>2</sup>	Operation voltage max.	Nominal voltage kV	Insulation thickness mm	Jacket thickness mm	Outer Ø min-max mm	Cop. Weight kg / km	Weight app. kg / km	AWG-No.
32400	1 x 35 rm/16	12	6/10	3.4	2.5	23 - 28	518	905	2
32401	1 x 50 rm/16	12	6/10	3.4	2.5	24 - 29	662	1080	1
32402	1 x 70 rm/16	12	6/10	3.4	2.5	26 - 31	854	1310	2/0
32403	1 x 95 rm/16	12	6/10	3.4	2.5	27 - 32	1094	1580	3/0
32404	1 x 120 rm/16	12	6/10	3.4	2.5	29 - 34	1334	1860	4/0
32405	1 x 150 rm/16	12	6/10	3.4	2.5	30 - 35	1622	2240	300 kcmil
32406	1 x 150 rm/25	12	6/10	3.4	2.5	30 - 35	1723	2010	300 kcmil
32407	1 x 185 rm/16	12	6/10	3.4	2.5	32 - 37	1958	2450	350 kcmil
32408	1 x 185 rm/25	12	6/10	3.4	2.5	32 - 37	2059	2580	350 kcmil
32409	1 x 240 rm/16	12	6/10	3.4	2.5	34 - 39	2486	3000	500 kcmil
32410	1 x 240 rm/25	12	6/10	3.4	2.5	34 - 39	2587	3130	500 kcmil
32411	1 x 300 rm/25	12	6/10	3.4	2.5	36 - 41	3163	3780	600 kcmil
32412	1 x 400 rm/35	12	6/10	3.4	2.5	40 - 45	4234	4670	750 kcmil
32413	1 x 500 rm/35	12	6/10	3.4	2.5	43 - 48	5194	5750	1000 kcmil
32414	1 x 35 rm/16	24	12/20	5.5	2.5	27 - 32	518	1110	2
32415	1 x 50 rm/16	24	12/20	5.5	2.5	28 - 33	662	1250	1
32416	1 x 70 rm/16	24	12/20	5.5	2.5	30 - 35	854	1510	2/0
32417	1 x 95 rm/16	24	12/20	5.5	2.5	31 - 36	1094	1780	3/0
32418	1 x 120 rm/16	24	12/20	5.5	2.5	33 - 38	1334	2070	4/0
32420	1 x 150 rm/25	24	12/20	5.5	2.5	34 - 39	1723	2420	300 kcmil
32419	1 x 150 rm/16	24	12/20	5.5	2.5	34 - 39	1622	2310	300 kcmil
32422	1 x 185 rm/25	24	12/20	5.5	2.5	36 - 41	2059	2810	350 kcmil
32421	1 x 185 rm/16	24	12/20	5.5	2.5	36 - 41	1958	2650	350 kcmil
32423	1 x 240 rm/16	24	12/20	5.5	2.5	39 - 44	2486	3260	500 kcmil
32424	1 x 240 rm/25	24	12/20	5.5	2.5	39 - 44	2587	3360	500 kcmil
32425	1 x 300 rm/25	24	12/20	5.5	2.5	41 - 46	3163	4020	600 kcmil
32426	1 x 400 rm/35	24	12/20	5.5	2.5	44 - 49	4234	4930	750 kcmil
32427	1 x 500 rm/35	24	12/20	5.5	2.5	47 - 52	5194	6050	1000 kcmil

Dimensions and specifications may be changed without prior notice. (RQ03)

Continuation »

# N2XS<sub>Y</sub> 6/10kV, 12/20kV, 18/30kV

Medium voltage cable, XLPE-insulated, Cu-conductor, single core, screened, PVC-jacket



Part No.	No. cores x cross-sec. mm <sup>2</sup>	Operation voltage max.	Nominal voltage kV	Insulation thickness mm	Jacket thickness mm	Outer Ø min-max mm	Cop. Weight kg / km	Weight app. kg / km	AWG-No.	
32428	1 x 50	rm/16	36	18/ 30	8	2,5	33 - 38	662	1480	1
32429	1 x 70	rm/16	36	18/ 30	8	2,5	35 - 40	854	1730	2/0
32430	1 x 95	rm/16	36	18/ 30	8	2,5	36 - 41	1094	2060	3/0
32431	1 x 120	rm/16	36	18/ 30	8	2,5	38 - 43	1334	2330	4/0
32432	1 x 150	rm/25	36	18/ 30	8	2,5	39 - 44	1723	2720	300 kcmil
32433	1 x 185	rm/25	36	18/ 30	8	2,5	41 - 46	2059	3100	350 kcmil
32434	1 x 240	rm/25	36	18/ 30	8	2,5	43 - 48	2587	3730	500 kcmil
32435	1 x 300	rm/25	36	18/ 30	8	2,5	46 - 51	3163	4000	600 kcmil
32436	1 x 400	rm/35	36	18/ 30	8	2,5	49 - 54	4234	5330	750 kcmil
32437	1 x 500	rm/35	36	18/ 30	8	2,5	52 - 57	5194	6480	1000 kcmil

Dimensions and specifications may be changed without prior notice. (RQ03)

## CABLE ACCESSORIES

The logical complement to our cable assortment.

As a meaningful addition to our comprehensive program of cables and wires, HELUKABEL<sup>®</sup>, has created a convincing cable accessory program that complies with the latest directives and standards.

### Some of the topics covered are:

- Cable glands
- Protective tubes
- Drag and guidance chains
- Insulation, shrunk, braided and high temperature tubes
- Termination and connection sleeves
- Bundling, binding and fixing
- Identification and marking
- Terminals and cable lugs
- Tools
- Signal and power connectors

Ask for more information, available in our current Cable Accessories catalogue via Internet or Fax (for Fax enquiry see page 71).



# N2XS2Y 6/10kV, 12/20kV, 18/30kV

Medium voltage cable, XLPE-insulated, Cu-conductor, single core, screened, PE-jacket



RoHS

## Technical Data

- XLPE-insulated power cables to IEC 60502, DIN VDE 0276 part 620, HD 620 S1
- **Temperature range**  
During installation up to -20°C
- **Operating temperature**  
Max. 90°C
- **Short circuit temperature**  
250°C (short circuit duration up to 5 sec.)
- **Nominal voltages**  
U<sub>0</sub>/U 6/10 kV, 12/20 kV, 18/30 kV
- **Operating voltages for**  
6/10 kV = max. 12 kV  
12/20 kV = max. 24 kV  
18/30 kV = max. 36 kV
- **Test voltages for**  
6/10 kV = 15 kV  
12/20 kV = 30 kV  
18/30 kV = 45 kV
- **Minimum bending radius**  
During installation max. 15x cable Ø

## Cable structure

- Circular bare cu-conductor of stranded wires to HD 383
- Inner semi-conducting coating
- Core insulation of cross-linked Polyethylene (XLPE), PE-compound DIX8 to HD 620.1
- Outer extrusion of semi-conducting coating spliced with the insulation
- Wrapping of conductive material
- Screen: Braiding of copper wires with one or two tapes applied helically
- Wrapping
- PE-outer jacket black, compound DMP2 to HD 620.1
- Jacket colour black

## Properties

- The materials used in manufacture are cadmium-free and contain no silicone and free from substances harmful to the wetting properties of lacquers
- **Installation notes**  
To guarantee an optimum on operating reliability the extruded semi-conductive layer is spliced with the insulation for long duration. For this reason we recommend a peeling tool for installation.

## Note

- Further dimensions available on request.

## Application

Suitable for indoor installation and in cable ducts, outdoors, underground and in water as well as for installation on cable trays for industries, switchboards and power stations. The PE-outer jacket is resistant to high mechanical stress for laying the cables. This PE-jacket is not flame-resistant (does not conform the test method B, as per VDE 0472 part 804).

The inner conducting layer between the conductor and the XLPE insulation and the firmly bonded outer conducting layer on the XLPE insulation assures a construction free of partial discharges with high operational reliability.

Part No.	No. cores x cross-sec. mm <sup>2</sup>	Operation voltage max.	Nominal voltage kV	Insulation thickness mm	Jacket thickness mm	Outer Ø min-max mm	Cop. Weight kg / km	Weight app. kg / km	AWG-No.
32480	1 x 35 rm / 16	12	6/10	3.4	2.5	23.0 -28.0	518.0	910.0	2
32481	1 x 50 rm / 16	12	6/10	3.4	2.5	24.0 -29.0	662.0	990.0	1
32482	1 x 70 rm / 16	12	6/10	3.4	2.5	26.0 -31.0	854.0	1205.0	2/0
32483	1 x 95 rm / 16	12	6/10	3.4	2.5	27.0 -32.0	1098.0	1520.0	3/0
32484	1 x 120 rm / 16	12	6/10	3.4	2.5	29.0 -34.0	1334.0	1760.0	4/0
32485	1 x 150 rm / 16	12	6/10	3.4	2.5	30.0 -35.0	1622.0	2020.0	300 kcmil
32486	1 x 150 rm / 25	12	6/10	3.4	2.5	30.0 -35.0	1725.0	2130.0	300 kcmil
32487	1 x 185 rm / 16	12	6/10	3.4	2.5	32.0 -37.0	1958.0	2360.0	350 kcmil
32488	1 x 185 rm / 25	12	6/10	3.4	2.5	32.0 -37.0	2059.0	2470.0	350 kcmil
32489	1 x 240 rm / 16	12	6/10	3.4	2.5	34.0 -39.0	2486.0	2960.0	500 kcmil
32490	1 x 240 rm / 25	12	6/10	3.4	2.5	34.0 -39.0	2587.0	3020.0	500 kcmil
32491	1 x 300 rm / 25	12	6/10	3.4	2.5	36.0 -41.0	3163.0	3630.0	600 kcmil
32492	1 x 400 rm / 35	12	6/10	3.4	2.5	40.0 -45.0	4234.0	4560.0	750 kcmil
32493	1 x 500 rm / 35	12	6/10	3.4	2.5	43.0 -48.0	5194.0	5580.0	1000 kcmil
32494	1 x 35 rm / 16	24	12/20	5.5	2.5	27.0 -32.0	518.0	960.0	2
32495	1 x 50 rm / 16	24	12/20	5.5	2.5	28.0 -33.0	662.0	1160.0	1
32496	1 x 70 rm / 16	24	12/20	5.5	2.5	30.0 -35.0	854.0	1410.0	2/0
32497	1 x 95 rm / 16	24	12/20	5.5	2.5	31.0 -36.0	1094.0	1670.0	3/0
32498	1 x 120 rm / 16	24	12/20	5.5	2.5	33.0 -38.0	1334.0	1960.0	4/0
32500	1 x 150 rm / 25	24	12/20	5.5	2.5	34.0 -39.0	1723.0	2310.0	300 kcmil
32499	1 x 150 rm / 16	24	12/20	5.5	2.5	34.0 -39.0	1622.0	2220.0	300 kcmil
32502	1 x 185 rm / 25	24	12/20	5.5	2.5	36.0 -41.0	2059.0	2670.0	350 kcmil
32501	1 x 185 rm / 16	24	12/20	5.5	2.5	36.0 -41.0	1958.0	2620.0	350 kcmil
32504	1 x 240 rm / 25	24	12/20	5.5	2.5	39.0 -44.0	2587.0	3270.0	500 kcmil
32503	1 x 240 rm / 16	24	12/20	5.5	2.5	39.0 -44.0	2486.0	3160.0	500 kcmil
32505	1 x 300 rm / 25	24	12/20	5.5	2.5	41.0 -46.0	3163.0	3880.0	600 kcmil
32506	1 x 400 rm / 35	24	12/20	5.5	2.5	44.0 -49.0	4234.0	4820.0	750 kcmil
32507	1 x 500 rm / 35	24	12/20	5.5	2.5	47.0 -52.0	5194.0	5860.0	1000 kcmil

Dimensions and specifications may be changed without prior notice. (RQ03)

Continuation »

# N2XS2Y 6/10kV, 12/20kV, 18/30kV

Medium voltage cable, XLPE-insulated, Cu-conductor, single core, screened, PE-jacket



Part No.	No. cores x cross-sec. mm <sup>2</sup>	Operation voltage max.	Nominal voltage kV	Insulation thickness mm	Jacket thickness mm	Outer Ø min-max mm	Cop. Weight kg / km	Weight app. kg / km	AWG-No.	
32508	1 x 50	rm / 16	36	18/30	8	2.5	33.0 -38.0	662.0	1410.0	1
32509	1 x 70	rm / 16	36	18/30	8	2.5	35.0 -40.0	854.0	1660.0	2/0
32510	1 x 95	rm / 16	36	18/30	8	2.5	36.0 -41.0	1094.0	1970.0	3/0
32511	1 x 120	rm / 16	36	18/30	8	2.5	38.0 -43.0	1334.0	2220.0	4/0
32512	1 x 150	rm / 25	36	18/30	8	2.5	39.0 -44.0	1723.0	2650.0	300 kcmil
32513	1 x 185	rm / 25	36	18/30	8	2.5	41.0 -46.0	2059.0	2980.0	350 kcmil
32514	1 x 240	rm / 25	36	18/30	8	2.5	43.0 -48.0	2587.0	3570.0	500 kcmil
32515	1 x 300	rm / 25	36	18/30	8	2.5	46.0 -51.0	3163.0	4220.0	600 kcmil
32516	1 x 400	rm / 35	36	18/30	8	2.5	49.0 -54.0	4234.0	5170.0	750 kcmil
32517	1 x 500	rm / 35	36	18/30	8	2.5	52.0 -57.0	5194.0	6260.0	1000 kcmil

Dimensions and specifications may be changed without prior notice. (RQ03)

## DATA, NETWORK & BUS TECHNOLOGY

The program for wiring the corporate-wide network infrastructure.

HELUKABEL offers a comprehensive service for networking heterogeneous systems in glass fibre and copper engineering. No matter if system-conform bus systems or innovative industrial Ethernet components. We have the solution. Independently developed products in the passive area and active components from renowned manufacturers form the backbone of our portfolio.

Our activities in this segment are distinguished with the brands



Request our Data, Network & Bus Technology catalogue through the Internet or via Fax (for Fax enquiry see page 71).

# NA2XS2Y 6/10kV, 12/20kV, 18/30kV

Medium voltage cable, XLPE-insulated, alu-conductor, single-core, screened, PE-jacket



RoHS

## Technical Data

- XLPE-insulated power cables to DIN VDE 0276 part 620, HD 620 S1 and IEC 60502
- **Temperature range**  
During installation up to -20°C
- **Operating temperature**  
Max. 90°C
- **Short circuit temperature**  
250°C (short circuit duration up to 5 sec.)
- **Nominal voltages**  
U<sub>0</sub>/U 6/10 kV, 12/20 kV, 18/30 kV
- **Operating voltages for**  
6/10 kV = max. 12 kV  
12/20 kV = max. 24 kV  
18/30 kV = max. 36 kV
- **Test voltages for**  
6/10 kV = 15 kV  
12/20 kV = 30 kV  
18/30 kV = 45 kV
- **Minimum bending radius**  
During installation max. 15x cable Ø

## Cable structure

- Circular bare alu-conductor of stranded wires to HD 383
- Inner semi-conducting coating
- Core insulation of cross-linked Polyethylene (XLPE), PE-compound DIX8 to HD 620.1
- Outer extrusion of semi-conducting coating spliced with the insulation
- Wrapping of conductive material
- Screen: Braiding of copper wires with one or two tapes applied helically
- Wrapping
- PE-outer jacket black, compound DMP2 to HD 620.1
- Jacket colour black

## Properties

- The materials used in manufacture are cadmium-free and contain no silicone and free from substances harmful to the wetting properties of lacquers
- **Installation notes**  
To guarantee an optimum on operating reliability the extruded semi-conductive layer is spliced with the insulation for long duration. For this reason we recommend a peeling tool for installation.

## Note

- Further dimensions available on request.

## Application

Suitable for indoor installation and in cable ducts, outdoors, underground and in water as well as for installation on cable trays for industries, switchboards and power stations. The PE-outer jacket is resistant to high mechanical stress for laying the cables. This PE-jacket is not flame-resistant (does not conform the test method B, as per VDE 0472 part 804).

The inner conducting layer between the conductor and the XLPE insulation and the firmly bonded outer conducting layer on the XLPE insulation assures a construction free of partial discharges with high operational reliability.

Part No.	No. cores x cross-sec. mm <sup>2</sup>	Operation voltage max.	Nominal voltage kV	Insulation thickness mm	Jacket thickness mm	Outer Ø min-max mm	Cop. Weight kg / km	Alu-weight kg / km	Weight app. kg / km	AWG-No.
32520	1 x 50 rm / 16	12	6 / 10	3.4	2.5	24.0 -29.0	182.0	145.0	710.0	1
32521	1 x 70 rm / 16	12	6 / 10	3.4	2.5	26.0 -31.0	182.0	203.0	790.0	2/0
32522	1 x 95 rm / 16	12	6 / 10	3.4	2.5	27.0 -32.0	182.0	276.0	920.0	3/0
32523	1 x 120 rm / 16	12	6 / 10	3.4	2.5	29.0 -34.0	182.0	348.0	990.0	4/0
32524	1 x 150 rm / 16	12	6 / 10	3.4	2.5	30.0 -35.0	182.0	435.0	1110.0	300 kcmil
32525	1 x 150 rm / 25	12	6 / 10	3.4	2.5	30.0 -35.0	283.0	435.0	1220.0	300 kcmil
32526	1 x 185 rm / 16	12	6 / 10	3.4	2.5	32.0 -37.0	182.0	537.0	1260.0	350 kcmil
32527	1 x 185 rm / 25	12	6 / 10	3.4	2.5	32.0 -37.0	283.0	537.0	1370.0	350 kcmil
32528	1 x 240 rm / 16	12	6 / 10	3.4	2.5	34.0 -39.0	182.0	696.0	1480.0	500 kcmil
32529	1 x 240 rm / 25	12	6 / 10	3.4	2.5	34.0 -39.0	283.0	696.0	1530.0	500 kcmil
32530	1 x 300 rm / 25	12	6 / 10	3.4	2.5	36.0 -41.0	283.0	870.0	1820.0	600 kcmil
32531	1 x 400 rm / 35	12	6 / 10	3.4	2.5	40.0 -45.0	394.0	1160.0	2220.0	750 kcmil
32532	1 x 500 rm / 35	12	6 / 10	3.4	2.5	43.0 -48.0	394.0	1450.0	2570.0	1000 kcmil
32533	1 x 50 rm / 16	24	12 / 20	5.5	2.5	28.0 -33.0	182.0	145.0	890.0	1
32534	1 x 70 rm / 16	24	12 / 20	5.5	2.5	30.0 -35.0	182.0	203.0	970.0	2/0
32535	1 x 95 rm / 16	24	12 / 20	5.5	2.5	31.0 -36.0	182.0	276.0	1120.0	3/0
32536	1 x 120 rm / 16	24	12 / 20	5.5	2.5	33.0 -38.0	182.0	348.0	1210.0	4/0
32538	1 x 150 rm / 25	24	12 / 20	5.5	2.5	34.0 -39.0	283.0	435.0	1420.0	300 kcmil
32537	1 x 150 rm / 16	24	12 / 20	5.5	2.5	34.0 -39.0	182.0	435.0	1370.0	300 kcmil
32539	1 x 185 rm / 16	24	12 / 20	5.5	2.5	36.0 -41.0	182.0	537.0	1530.0	350 kcmil
32540	1 x 185 rm / 25	24	12 / 20	5.5	2.5	36.0 -41.0	283.0	537.0	1570.0	350 kcmil
32542	1 x 240 rm / 25	24	12 / 20	5.5	2.5	39.0 -44.0	283.0	696.0	1830.0	500 kcmil
32541	1 x 240 rm / 16	24	12 / 20	5.5	2.5	39.0 -44.0	182.0	696.0	1720.0	500 kcmil
32543	1 x 300 rm / 25	24	12 / 20	5.5	2.5	41.0 -46.0	283.0	870.0	2070.0	600 kcmil
32544	1 x 400 rm / 35	24	12 / 20	5.5	2.5	44.0 -49.0	394.0	1160.0	2460.0	750 kcmil
32545	1 x 500 rm / 35	24	12 / 20	5.5	2.5	47.0 -52.0	394.0	1450.0	2890.0	1000 kcmil

Dimensions and specifications may be changed without prior notice. (RQ03)

Continuation »

# NA2XS2Y 6/10kV, 12/20kV, 18/30kV

Medium voltage cable, XLPE-insulated, alu-conductor, single-core, screened, PE-jacket



Part No.	No. cores x cross-sec. mm <sup>2</sup>	Operation voltage max.	Nominal voltage kV	Insulation thickness mm	Jacket thickness mm	Outer Ø min-max mm	Cop. Weight kg / km	Alu-weight kg / km	Weight app. kg / km	AWG-No.
32546	1 x 50 rm / 16	36	18 / 30	8.0	2.5	33.0 - 38.0	182.0	145.0	1120.0	1
32547	1 x 70 rm / 16	36	18 / 30	8.0	2.5	35.0 - 40.0	182.0	203.0	1270.0	2/0
32548	1 x 95 rm / 16	36	18 / 30	8.0	2.5	36.0 - 41.0	182.0	276.0	1380.0	3/0
32549	1 x 120 rm / 16	36	18 / 30	8.0	2.5	38.0 - 43.0	182.0	348.0	1530.0	4/0
32550	1 x 150 rm / 25	36	18 / 30	8.0	2.5	39.0 - 44.0	283.0	435.0	1720.0	300 kcmil
32551	1 x 185 rm / 25	36	18 / 30	8.0	2.5	41.0 - 46.0	283.0	537.0	1860.0	350 kcmil
32552	1 x 240 rm / 25	36	18 / 30	8.0	2.5	43.0 - 48.0	283.0	696.0	2110.0	500 kcmil
32553	1 x 300 rm / 25	36	18 / 30	8.0	2.5	46.0 - 51.0	283.0	870.0	2370.0	600 kcmil
32554	1 x 400 rm / 35	36	18 / 30	8.0	2.5	49.0 - 54.0	394.0	1160.0	2820.0	750 kcmil
32555	1 x 500 rm / 35	36	18 / 30	8.0	2.5	52.0 - 57.0	394.0	1450.0	3280.0	1000 kcmil

Dimensions and specifications may be changed without prior notice. (RQ03)

## MEDIA TECHNOLOGY

### The assortment of cables and wires for media technology.

Our assortment for media technology includes wires for both indoor and outdoor use and guarantees high transmission quality in both fixed installations as well as in mobile use.

Our comprehensive range includes amongst others

- Audio cables according to AES/EBU
- DMX cables
- Loudspeaker cables
- Video cables
- Microphone cables
- Instrument cables
- Special purpose cables according to your requirements

Our activities in this segment are distinguished with the brands

**HELULIGHT**<sup>®</sup>

**HELUSOUND**<sup>®</sup>

Ph. +49 7150 9209-773 or  
medientechnik@helukabel.de

Just give us a call. We would be glad to advise you

Request our special Media Technology catalogue through the Internet or via Fax (for Fax enquiry see page 71).



# N2XS(F)2Y 6/10kV, 12/20kV, 18/30kV Medium voltage cable, XLPE-insulated, Cu-conductor, singel core, screened, longitudinally water-tight, PE-jacket



RoHS

## Technical Data

- XLPE-insulated power cables to DIN VDE 0276 part 620, HD 620 S1 and IEC 60502
- **Temperature range**  
During installation up to -20°C
- **Operating temperature**  
Max. 90°C
- **Short circuit temperature**  
250°C (short circuit duration up to 5 sec.)
- **Nominal voltages**  
U<sub>n</sub>/U 6/10 kV, 12/20 kV, 18/30 kV
- **Operating voltages for**  
6/10 kV = max. 12 kV  
12/20 kV = max. 24 kV  
18/30 kV = max. 36 kV
- **Test voltages for**  
6/10 kV = 15 kV  
12/20 kV = 30 kV  
18/30 kV = 45 kV
- **Minimum bending radius**  
During installation max. 15x cable Ø

## Cable structure

- Circular bare Cu-conductor of stranded wires to DIN VDE 0295 cl. 2 bzw. IEC 60228 cl. 2
- Inner semi-conducting coating
- Core insulation of cross-linked Polyethylene (XLPE), PE-compound DIX8 to HD 620.1
- Outer extrusion of semi-conducting coating spliced with the XLPE-insulation
- Longitudinally water-tight, conductive wrapping
- Screen: Braiding of copper wires with one or two tapes applied helically
- Longitudinally water-tight wrapping
- PE-outer jacket, compound DMP2 to HD 620.1
- Jacket colour black

## Properties

- The materials used in manufacture are cadmium-free and contain no silicone and free from substances harmful to the wetting properties of lacquers
- **Installation notes**  
To guarantee an optimum on operating reliability the extruded semi-conductive layer is spliced with the insulation for long duration. For this reason we recommend a peeling tool for installation

## Note

- AWG sizes are approximate equivalent values. The actual cross-section is in mm<sup>2</sup>.
- For longitudinally and crosswise water-tight cable type N2XS(F)2Y with PE-copolymere coated aluminium.
- Further types and dimensions on request.

## Application

Suitable for indoor installation and in cable ducts, outdoors, underground and in water as well as for installation on cable trays for industries, switchboards and power stations. The PE-outer jacket is resistant to high mechanical stress for laying the cables. This PE-jacket is not flame-resistant (does not conform the test method B, as per VDE 0472 part 804).

The inner conducting layer between the conductor and the XLPE insulation and the firmly bonded outer conducting layer on the XLPE insulation assures a construction free of partial discharges with high operational reliability.

Part No.	No. cores x cross-sec. mm <sup>2</sup>	Operation voltage max.	Nominal voltage kV	Insulation thickness mm	Screen cross-sec. mm <sup>2</sup>	Jacket thickness mm	Outer Ø app. mm	Cop. Weight kg / km	Weight app. kg / km	AWG-No.
32560	1x 35 rm / 16	12	6 / 10	3.4	16.0	2.5	26.0	518.0	1050.0	2
32561	1x 50 rm / 16	12	6 / 10	3.4	16.0	2.5	28.0	662.0	1150.0	1
32562	1x 70 rm / 16	12	6 / 10	3.4	16.0	2.5	30.0	854.0	1460.0	2/0
32563	1x 95 rm / 16	12	6 / 10	3.4	16.0	2.5	31.0	1094.0	1700.0	3/0
32564	1x 120 rm / 16	12	6 / 10	3.4	16.0	2.5	32.0	1334.0	2030.0	4/0
32565	1x 150 rm / 25	12	6 / 10	3.4	25.0	2.5	34.0	1723.0	2350.0	300 kcmil
32566	1x 185 rm / 25	12	6 / 10	3.4	25.0	2.5	36.0	2059.0	2700.0	350 kcmil
32567	1x 240 rm / 25	12	6 / 10	3.4	25.0	2.5	38.0	2587.0	3300.0	500 kcmil
32568	1x 300 rm / 25	12	6 / 10	3.4	25.0	2.5	40.0	3163.0	3900.0	600 kcmil
32569	1x 400 rm / 35	12	6 / 10	3.4	35.0	2.5	44.0	4234.0	4850.0	750 kcmil
32570	1x 500 rm / 35	12	6 / 10	3.4	35.0	2.5	47.0	5194.0	6000.0	1000 kcmil
32571	1x 35 rm / 16	24	12 / 20	5.5	16.0	2.5	31.0	518.0	1210.0	2
32572	1x 50 rm / 16	24	12 / 20	5.5	16.0	2.5	33.0	662.0	1400.0	1
32573	1x 70 rm / 16	24	12 / 20	5.5	16.0	2.5	34.0	854.0	1550.0	2/0
32574	1x 95 rm / 16	24	12 / 20	5.5	16.0	2.5	36.0	1094.0	1800.0	3/0
32575	1x 120 rm / 16	24	12 / 20	5.5	16.0	2.5	37.0	1334.0	2150.0	4/0
32576	1x 150 rm / 25	24	12 / 20	5.5	25.0	2.5	39.0	1723.0	2400.0	300 kcmil
32577	1x 185 rm / 25	24	12 / 20	5.5	25.0	2.5	41.0	2059.0	2850.0	350 kcmil
32578	1x 240 rm / 25	24	12 / 20	5.5	25.0	2.5	43.0	2587.0	3250.0	500 kcmil
32579	1x 300 rm / 25	24	12 / 20	5.5	25.0	2.5	45.0	3163.0	3850.0	600 kcmil
32580	1x 400 rm / 35	24	12 / 20	5.5	35.0	2.5	48.0	4234.0	4900.0	750 kcmil
32581	1x 500 rm / 35	24	12 / 20	5.5	35.0	2.5	52.0	5194.0	6100.0	1000 kcmil

Dimensions and specifications may be changed without prior notice. (RQ03)

Continuation >>



Part No.	No. cores x cross-sec. mm <sup>2</sup>	Operation voltage max.	Nominal voltage kV	Insulation thickness mm	Screen cross-sec. mm <sup>2</sup>	Jacket thickness mm	Outer Ø app. mm	Cop. Weight kg / km	Weight app. kg / km	AWG-No.
32582	1 x 50 rm / 16	36	18 / 30	8.0	16.0	2.5	37.0	662.0	1700.0	1
32583	1 x 70 rm / 16	36	18 / 30	8.0	16.0	2.5	38.0	854.0	1950.0	2/0
32584	1 x 95 rm / 16	36	18 / 30	8.0	16.0	2.5	40.0	1094.0	2300.0	3/0
32585	1 x 120 rm / 16	36	18 / 30	8.0	16.0	2.5	42.0	1334.0	2600.0	4/0
32586	1 x 150 rm / 25	36	18 / 30	8.0	25.0	2.5	43.0	1723.0	3000.0	300 kcmil
32587	1 x 185 rm / 25	36	18 / 30	8.0	25.0	2.5	45.0	2059.0	3350.0	350 kcmil
32588	1 x 240 rm / 25	36	18 / 30	8.0	25.0	2.5	47.0	2587.0	4100.0	500 kcmil
32589	1 x 300 rm / 25	36	18 / 30	8.0	25.0	2.5	50.0	3163.0	4800.0	600 kcmil
32590	1 x 400 rm / 35	36	18 / 30	8.0	35.0	2.5	53.0	4234.0	5750.0	750 kcmil
32591	1 x 500 rm / 35	36	18 / 30	8.0	35.0	2.5	56.0	5194.0	6700.0	1000 kcmil

Dimensions and specifications may be changed without prior notice. (RQ03)

## RESEARCH AND DEVELOPMENT

Our design engineers develop and test new cable and wire types up to series maturity.

New products are tested for their applicability and their readiness for production in the state-of-the-art equipped test centre at our factory in Windsbach. In-process measurements and random samples secure our high quality standard.

Products for mobile use with a very high depth of manufacturing build up a main core of the range. Extreme chemical, electrical and mechanical loads paired with small bending radii, a high number of alternating bending cycles and exceptional service lives are requirements made by our customers that we gladly meet.

We would also be glad to develop your cable made to measure.  
Give us a call at Ph. +49 7150 9209-731 or -135

### A development example:

The cargo ship MS Beluga is being pulled by the SkySail using wind power. The traction cable including the control wire being used for this, which was designed, developed and produced by HELUKABEL®.



# NA2XS(F)2Y 6/10kV, 12/20kV, 18/30kV Medium voltage cable, XLPE-insulated, alu-conductor, singel core, screened, longitudinally water-tight, PE-jacket



RoHS

## Technical Data

- XLPE-insulated power cables to DIN VDE 0276 part 620, HD 620 S1 and IEC 60502
- **Temperature range**  
During installation up to -20°C
- **Operating temperature**  
Max. 90°C
- **Short circuit temperature**  
250°C (short circuit duration up to 5 sec.)
- **Nominal voltages**  
U<sub>0</sub>/U 6/10 kV, 12/20 kV, 18/30 kV
- **Operating voltages for**  
6/10 kV = max. 12 kV  
12/20 kV = max. 24 kV  
18/30 kV = max. 36 kV
- **Test voltages for**  
6/10 kV = 15 kV  
12/20 kV = 30 kV  
18/30 kV = 45 kV
- **Minimum bending radius**  
During installation max. 15x cable Ø

## Cable structure

- Circular bare alu-conductor of stranded wires to DIN VDE 0295 cl. 2 and IEC 60228 cl. 2
- Inner semi-conducting coating
- Core insulation of cross-linked Polyethylene (XLPE), PE-compound DIX8 to HD 620.1
- Outer extrusion of semi-conducting coating spliced with the XLPE-insulation
- Longitudinally water-tight, conductive wrapping
- Screen: Braiding of copper wires with one or two tapes applied helically
- Longitudinally water-tight wrapping
- PE-outer jacket, compound DMP2 to HD 620.1
- Jacket colour black
- Jacket thickness voltage 2,5 mm

## Properties

- The materials used in manufacture are cadmium-free and contain no silicone and free from substances harmful to the wetting properties of lacquers
- **Installation notes**  
To guarantee an optimum on operating reliability the extruded semi-conductive layer is spliced with the insulation for long duration. For this reason we recommend a peeling tool for installation.

## Note

- AWG sizes are approximate equivalent values. The actual cross-section is in mm<sup>2</sup>.
- For longitudinally and crosswise water-tight cable type NA2XS(FL)2Y with PE-copolymere coated aluminium.
- Further types and dimensions on request.

## Application

Suitable for indoor installation and in cable ducts, outdoors, underground and in water as well as for installation on cable trays for industries, switchboards and power stations. The PE-outer jacket is resistant to high mechanical stress for laying the cables. This PE-jacket is not flame-resistant (does not conform the test method B, as per VDE 0472 part 804).

The inner conducting layer between the conductor and the XLPE insulation and the firmly bonded outer conducting layer on the XLPE insulation assures a construction free of partial discharges with high operational reliability.

Part No.	No. cores x cross-sec. mm <sup>2</sup>	Operation voltage max.	Nominal voltage kV	Insulation thickness mm	Screen cross-sec. mm <sup>2</sup>	Outer Ø app. mm	Cop. Weight kg / km	Alu weight kg / km	Weight app. kg / km	AWG-No.
32600	1 x 35 rm / 16	12	6 / 10	3.4	16.0	26.0	182.0	102.0	780.0	2
32601	1 x 50 rm / 16	12	6 / 10	3.4	16.0	28.0	182.0	145.0	850.0	1
32602	1 x 70 rm / 16	12	6 / 10	3.4	16.0	30.0	182.0	203.0	980.0	2/0
32603	1 x 95 rm / 16	12	6 / 10	3.4	16.0	31.0	182.0	276.0	1080.0	3/0
32604	1 x 120 rm / 16	12	6 / 10	3.4	16.0	32.0	182.0	348.0	1150.0	4/0
32605	1 x 150 rm / 25	12	6 / 10	3.4	25.0	34.0	283.0	435.0	1280.0	300 kcmil
32606	1 x 185 rm / 25	12	6 / 10	3.4	25.0	36.0	283.0	537.0	1420.0	350 kcmil
32607	1 x 240 rm / 25	12	6 / 10	3.4	25.0	38.0	283.0	696.0	1630.0	500 kcmil
32608	1 x 300 rm / 25	12	6 / 10	3.4	25.0	40.0	283.0	870.0	1950.0	600 kcmil
32609	1 x 400 rm / 35	12	6 / 10	3.4	35.0	44.0	394.0	1160.0	2350.0	750 kcmil
32610	1 x 500 rm / 35	12	6 / 10	3.4	35.0	47.0	394.0	1450.0	2780.0	1000 kcmil
32611	1 x 50 rm / 16	24	12 / 20	5.5	16.0	33.0	182.0	145.0	920.0	1
32612	1 x 70 rm / 16	24	12 / 20	5.5	16.0	34.0	182.0	203.0	1030.0	2/0
32613	1 x 95 rm / 16	24	12 / 20	5.5	16.0	36.0	182.0	276.0	1140.0	3/0
32614	1 x 120 rm / 16	24	12 / 20	5.5	16.0	37.0	182.0	348.0	1250.0	4/0
32615	1 x 150 rm / 25	24	12 / 20	5.5	25.0	39.0	283.0	435.0	1320.0	300 kcmil
32616	1 x 185 rm / 25	24	12 / 20	5.5	25.0	41.0	283.0	537.0	1570.0	350 kcmil
32617	1 x 240 rm / 25	24	12 / 20	5.5	25.0	43.0	283.0	696.0	1780.0	500 kcmil
32618	1 x 300 rm / 25	24	12 / 20	5.5	25.0	45.0	283.0	870.0	2100.0	600 kcmil
32619	1 x 400 rm / 35	24	12 / 20	5.5	35.0	48.0	394.0	1160.0	2480.0	750 kcmil
32620	1 x 500 rm / 35	24	12 / 20	5.5	35.0	52.0	394.0	1450.0	2900.0	1000 kcmil

Dimensions and specifications may be changed without prior notice. (RQ03)

Continuation »

# NA2XS(F)2Y 6/10kV, 12/20kV, 18/30kV Medium voltage cable, XLPE-insulated, alu-conductor, singel core, screened, longitudinally water-tight, PE-jacket



Part No.	No.cores x cross-sec. mm <sup>2</sup>	Operation voltage max.	Nominal voltage kV	Insulation thickness mm	Screen cross-sec. mm <sup>2</sup>	Outer Ø app. mm	Cop. Weight kg / km	Alu weight kg / km	Weight app. kg / km	AWG-No.
32621	1 x 50 rm / 16	36	18 / 30	8.0	16.0	37.0	182.0	145.0	1250.0	1
32622	1 x 70 rm / 16	36	18 / 30	8.0	16.0	38.0	182.0	203.0	1500.0	2/0
32623	1 x 95 rm / 16	36	18 / 30	8.0	16.0	40.0	182.0	276.0	1700.0	3/0
32624	1 x 120 rm / 16	36	18 / 30	8.0	16.0	42.0	182.0	348.0	1800.0	4/0
32625	1 x 150 rm / 25	36	18 / 30	8.0	25.0	43.0	283.0	435.0	2050.0	300 kcmil
32626	1 x 185 rm / 25	36	18 / 30	8.0	25.0	45.0	283.0	537.0	2150.0	350 kcmil
32627	1 x 240 rm / 25	36	18 / 30	8.0	25.0	47.0	283.0	696.0	2400.0	500 kcmil
32628	1 x 300 rm / 25	36	18 / 30	8.0	25.0	50.0	283.0	870.0	2700.0	600 kcmil
32629	1 x 400 rm / 35	36	18 / 30	8.0	35.0	53.0	394.0	1160.0	3200.0	750 kcmil
32630	1 x 500 rm / 35	36	18 / 30	8.0	35.0	56.0	394.0	1450.0	3555.0	1000 kcmil

Dimensions and specifications may be changed without prior notice. (RQ03)

## The logistics centre – our service excellence

The majority of the product range that includes over 33,000 products is kept ready on a storage area of 160,000 m<sup>2</sup> in our central warehouse Hemmingen/Germany. The main linchpin for that is the logistics centre at the headquarters in Hemmingen.

With its commissioning in 2001 HELUKABEL reacted to the increased market requirements. The goal was and is accelerated and paperless processing and delivery of customer orders while maintaining a high level of efficiency within the supply chain. State-of-the-art warehousing and conveyor equipment along with continuous informati- on technology make the plant unique in the sector.

Extensively automated, several hundred orders are compiled daily “just in time” from over 16,000 pallet storage spaces, and over 1600 length cuts are made every day. Dispatching on a worldwide scale in over 60 countries, packing seaworthy and labelling in 14 languages is our daily business today – perhaps tomorrow for you too?



Logistic Centre Hemmingen/Germany

# N2XSEY 3x ... 6/10kV

medium voltage cable, XLPE-insulated, Cu-conductor, PVC-jacket

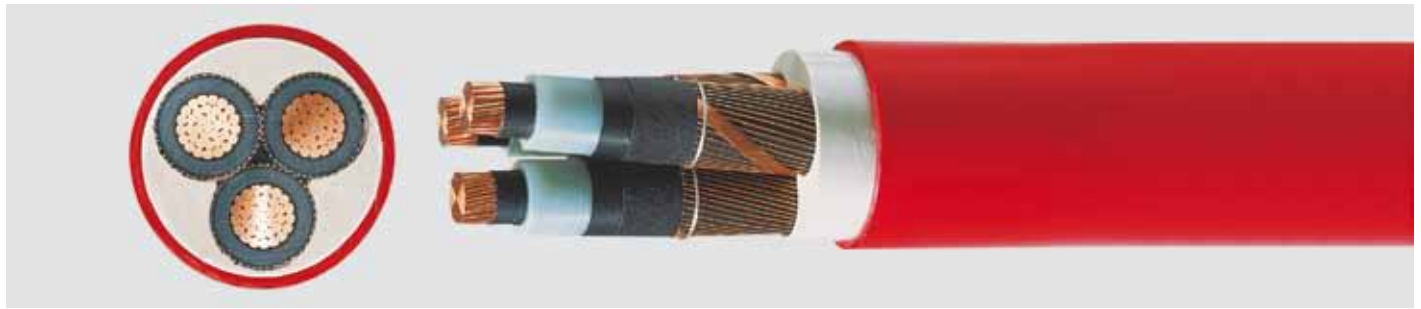

## Technical Data

- Three core XLPE-insulated power cables to VDE 0276 and IEC 60502
- **Temperature range**  
during installation up to -5°C
- **Operating temperature**  
max. 90°C
- **Short circuit temperature**  
core 250°C  
screen 350°C (duration)  
(short circuit duration up to 5 sec.)
- **Nominal voltages**  $U_0/U$  6/10 kV
- **Operating voltages**  
max. 12 kV
- **Test voltages** 15 kV
- **Test voltages d.c.** 48 kV
- **Power rating**  
to DIN VDE 0298 part 2
- **Minimum bending radius**  
during installation 15x cable  $\varnothing$
- **Tests**  
according to DIN VDE 0276 und IEC 60502

## Cable structure

- Circular bare Cu-conductor of stranded wires to DIN VDE 0295 cl. 2 and IEC 60228 cl. 2
- Inner semi-conducting coating
- Core insulation of cross-linked Polyethylene (XLPE), PE-compound DIX8 to HD 620.1
- Outer extrusion of semi-conducting coating spliced with the XLPE-insulation
- Conductive wrapping
- Screen: Braiding of copper wires with one or two tapes applied helically
- 3 cores stranded
- Extruded sheath over three cores
- PVC outer jacket, compound DMV6 to HD 405.1 and HD 620/1
- Jacket colour red

## Properties

- self-extinguishing and flame retardant according to DIN VDE 0482 part 265-2-1/ EN 50265-2-1/ IEC 60332-1 (equivalent DIN VDE 0472 part 804 test method B)
- The materials used in manufacture are cadmium-free and contain no silicone and free from substances harmful to the wetting properties of lacquers
- **Installation notes**  
To guarantee an optimum on operating reliability the extruded semi-conductive layer is spliced with the insulation for long duration. For this reason we recommend a peeling tool for installation.

## Note

- AWG sizes are approximate equivalent values. The actual cross-section is in mm<sup>2</sup>.
- For laying in earth: For ground thermal resistivity of 1 K-m/W, laying depth 0,7 m, ground temperature 20°C, EVU load grade 0,7.
- For laying in air: Air temperature 30°C, EVU load grade 1,0.
- Conversion factors for laying in earth especially for laying in bundle form and other requirements are noted in DIN VDE 0298 part 2 and 0276 part 1000.
- Conversion factors for laying in air  
Air temperature/Conversion factor  
15°C/1,12; 20°C/1,08; 25°C/1,04; 30°C/1,0; 35°C/0,96; 40°C/0,91; 45°C/0,87; 50°C/0,82;

## Power rating and electrical characteristics

Cross-sec. mm <sup>2</sup>	Power ratings		Conductor resistance 20° C Ω/km	Operating capacity μF/km	Effective resistance 90° C Ω/km	Inductance per core mH/km
	laying in earth	laying in air				
3 x 25 rm/16	151	147	0.727	0.203	0.928	0.399
3 x 35 rm/16	181	178	0.524	0.225	0.669	0.378
3 x 50 rm/16	213	213	0.387	0.249	0.494	0.359
3 x 70 rm/16	261	265	0.268	0.283	0.343	0.338
3 x 95 rm/16	312	322	0.193	0.315	0.247	0.323
3 x 120 rm/16	355	370	0.153	0.345	0.197	0.311
3 x 150 rm/25	399	420	0.124	0.374	0.160	0.302
3 x 185 rm/25	451	481	0.0991	0.406	0.129	0.293
3 x 240 rm/25	523	566	0.0754	0.456	0.0991	0.282
3 x 300 rm/25	590	648	0.0601	0.495	0.0803	0.274

## Application

Suitable for installation in indoors and in cable ducts, outdoors as well as for laying on racks for industrial and switching systems and power plants. Limited use when buried in the earth if the PVC outer jacket could be damaged by high mechanical stress.

The inner conducting layer between the conductor and the XLPE insulation and the firmly bonded outer conducting layer on the XLPE insulation assures a construction free of partial discharges with high operational reliability.

Part No.	No. cores x cross-sec. mm <sup>2</sup>	Insulation thickness mm	Screen cross-sec. mm <sup>2</sup>	Jacket thickness mm	Outer $\varnothing$ app. mm	Cop. Weight kg / km	Weight app. kg / km	AWG-No.
34339	3 x 25 rm / 16	3.4	16.0	2.5	43.0	1046.0	2850.0	4
34340	3 x 35 rm / 16	3.4	16.0	2.5	48.0	1210.0	3300.0	2
34341	3 x 50 rm / 16	3.4	16.0	2.5	50.0	1670.0	3750.0	1
34342	3 x 70 rm / 16	3.4	16.0	2.6	54.0	2250.0	4650.0	2/0
34343	3 x 95 rm / 16	3.4	16.0	2.8	58.0	2995.0	5700.0	3/0
34344	3 x 120 rm / 16	3.4	16.0	2.9	61.0	3715.0	6700.0	4/0
34345	3 x 150 rm / 25	3.4	25.0	3.0	65.0	4635.0	7900.0	300 kcmil
34346	3 x 185 rm / 25	3.4	25.0	3.1	68.0	5645.0	9200.0	350 kcmil
34347	3 x 240 rm / 25	3.4	25.0	3.3	74.0	7274.0	11450.0	500 kcmil
34348	3 x 300 rm / 25	3.4	25.0	3.3	79.0	9160.0	14450.0	600 kcmil

Dimensions and specifications may be changed without prior notice. (RQ03)

# Notes

---

## Changes to specifications

© HELUKABEL® GmbH Hemmingen, Germany

Specifications subject to change without notice. All illustrations, symbols, markings, numbering, etc. on the outer jacket are therefore to be considered as provisional. Differences in colour between photos and delivered goods cannot be prevented. All rights for reprinting or reproduction of text and illustrations, in whole or in part, reserved. The transfer of copyright principally requires the written permission of HELUKABEL® GmbH.

## Length markings

The length marking, which cannot be officially verified, is intended merely as an aid (e.g. as a measuring guide or for the purpose of determining how much material is left on the drum). The actual cable length may deviate from that indicated by the length marking by up to 1%. No legal liability can be assumed for incomplete or patchy length markings, or if the actual cable length deviates from that indicated by the length marking. The only means of determining the actual cable length is to use calibrated measuring equipment.

## Safety note

The products described here are produced in accordance with national or international standards as well as company standards; application safety is observed in accordance with the relevant safety directives, standards and legal requirements. This notwithstanding, the products are subject to the specifications of the relevant DIN VDE requirements. However, assembly and handling may only be undertaken by electrical specialists.

**Our general terms and conditions of delivery and payment apply; available at [www.helukabel.de](http://www.helukabel.de).**



Between panel and inverter - connecting method from a single source. Whether you need products for solar cabling on open land...

Foto: HELUKABEL®



... or solar cabling on buildings, HELUKABEL® can offer you exactly the right solution.

Foto: HELUKABEL®

# Achieving success through quality and innovation



ISO 9000ff is used as the basis for quality management processes carried out at HELUKABEL®. Product certificates issued by accredited institutions also make supplier evaluation easier from your perspective.

Our continuous quality improvement process enables us not only to maintain a consistently high standard of quality, but also ensures ongoing product development and innovations.

## Our commitment to protecting the environment can be seen in our first-rate environmental management systems



We have expanded our SOLARFLEX®-X PV1-F product portfolio up to 240 mm<sup>2</sup>. New TÜV- and VDE certificates for SOLARFLEX®-X PV1-F 2,5 mm<sup>2</sup> to 240 mm<sup>2</sup> are in progress and will be issued shortly.

## HELUKABEL® – global network

Country	Phone	Fax	e-Mail
 HELUKABEL® Germany	+49 7159 9209-0	+49 7150 81786	info@helukabel.de
 HELUKABEL® Switzerland	+41 56 4181515	+41 56 4181516	info@helukabel.ch
 HELUKABEL® Italy	+39 039 9515450	+39 039 9281579	info@helukabel.it
 HELUKABEL® Poland	+48 46 8580100	+48 46 8580117	info@helukabel.pl
 HELUKABEL® Netherlands	+31 495 499049	+31 495 499048	info@helukabel.nl
 HELUKABEL® France	+33 389 627562	+33 389 627700	info@helukabel.fr
 HELUKABEL® Belgium	+32 24 810020	+32 24 810022	info@helukabel.be
 HELUKABEL® China	+86 21 5869 6108	+86 21 5869 3666	info@helukabel.com.cn
 HELUKABEL® Sweden	+46 8 7617805	+46 8 6210059	info@helukabel.se
 HELUKABEL® Czech Republic	+42 0 312 672620	+42 0 312 672621	info@helukabel.cz
 HELUKABEL® Russia	+49 7150 9209389	+49 7150 922695	info@helukabel.ru
 HELUKABEL® India	+91 22 25185841	+91 22 25185839	info@helukabel.in
 HELUKABEL® Singapore	+65 64 880170	+65 62 851513	info@helukabel.sg
 HELUKABEL® Malaysia	+603 7885 8724	+603 7885 7825	info@helukabel.com.my
 HELUKABEL® Korea	+82 51 972 8646	+82 51 972 8649	info@helukabel.co.kr
 HELUKABEL® Thailand	+66 292735703	+66 29215402	info@helukabel.co.th
 HELUKABEL® Slovakia	+42 19 15751549	+42 19 03595382	info@helukabel.sk
 HELUKABEL® Turkey	+90 212 5024195	+90 212 5024198	info@helukabel.com.tr
 HELUKABEL® USA	+01 847 9305118	+01 847 6228766	sales@helukabel.com
 HELUKABEL® South Africa	+27 11 4628752	+27 11 4628638	info@helukabel.co.za

## FAX enquiry form copy and fax straight forward (fax no. see above)

**I would like to know more about HELUKABEL®.**

**Please send me the following catalogue:**

- Cables & Wires
- Cable Accessories
- Data, Network & Bus Technology
- Media Technology

**We would like:**

- General documentation
- A visit from a factory representative
- A quotation for: \_\_\_\_\_

Sender (stamp)

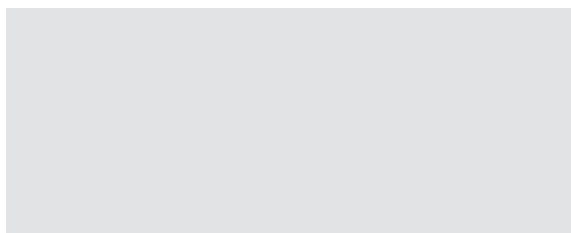

HELUKABEL® GmbH  
 Dieselstraße 8-12  
 71282 Hemmingen, Germany  
 Phone +49 7150 9209-0  
 Fax +49 7150 81786

Contacts



Photo: Our production in the Windsbach plant with a modern photovoltaic system with 1125 solar modules. The system provides an annual energy amount of 970 kWh per KWp = 185,512 kWh. This saves our environment approx. 111 tons of CO<sub>2</sub> per year.

**HELUKABEL® GmbH · Headquarters**  
Dieselstraße 8-12 · 71282 Hemmingen, Germany  
Phone +49 7150 9209-0 · Fax +49 7150 81786  
info@helukabel.de · www.helukabel.de

**International branches**  
Switzerland · France · Slovakia · Sweden · Italy  
Belgium · Netherlands · Poland · Czech Republic  
Turkey · Russia · USA · South Korea · China · India  
Thailand · Singapore · Malaysia · South Africa